



SELF-DRIVE BOATING HOLIDAYS
NO EXPERIENCE NEEDED!



France | Germany | Portugal | Netherlands | Hungary

WITH NICOLS, SET SAIL FOR SOME OF THE MOST BEAUTIFUL DESTINATIONS!



WHY MORE AND MORE PEOPLE ARE CHOOSING NICOLS®



- All our boats are made in our shipyard in **France**.
- **Smart and bright** house boats.
- Family friendly boats where **safety is paramount**.
- Small bases with **knowledgeable and friendly staff**.

- **Excellent savings** for our loyal customers.
- Cruising itineraries on **the most beautiful waterways in France and in Europe**.
- **A welcome present** waiting for you on arrival aboard.
- And lastly.... **our heated pool** (exclusive to NICOLS®) perfect for children... and for adults!

AHOY THERE!



Holiday happiness is quite simple... It's being out on the water.

Don't just dream about it. Instead round up a crew of family and friends and start exploring the beautiful canals and rivers of France and Europe with Nicols. Whether it's a weekend trip, a short break or a longer holiday you'll travel from lock to lock, from village to village, aboard a stylish and fully-equipped boat that can accommodate from 2 to 12 people. You'll enjoy an unforgettable journey in the greatest of comfort.

Don't worry if you've never been on a boat before. No previous boating experience is needed and our Nicols base teams will be there to show you the ropes on the day of departure and will quickly turn you into an excellent captain!

To find out all about our many holiday itineraries and discover our boats, plus find out the basics about boat hire and get a holiday price, please get in touch. We are just a call or click away to help you plan and prepare for your boating holiday.



CONTENTS



- 05 • Holidays everyone will love
- 05 • Nicols® vouchers
- 06 • Get ready for your cruise
- 08 • Even more to enjoy
- 10 • Themed cruises
- 11 • Let's take care of the environment together!

→ FRANCE

- 12 • Brittany
- 14 • Anjou
- 16 • Charente
- 18 • Lot
- 20 • Aquitaine
- 22 • Midi
- 24 • Camargue
- 26 • Val de Loire • Nivernais
- 28 • Burgundy
- 30 • Franche-Comté • Saône
- 32 • Alsace

→ GERMANY

- 34 • Mecklenburg-West
- 36 • Mecklenburg-East

→ NETHERLANDS

- 38 • Holland

→ HUNGARY

- 40 • Tokaj
- 40 • Lake Tizja

→ PORTUGAL

- 42 • Lago Alqueva

→ NICOLS® FLEET

- 46 • FLY range
- 49 • ESTIVALE, CONFORT, SEDAN and RIVIERA ranges
- 59 • The Nicols story
- 59 • Own your own Nicols® boat!

→ PRICES

Prices and information on how to book can be found at the centre of the brochure.

2022 edition | Photos

© A. Duerst | © A. Le Doledec | © Adobe Stock | © Adobe Stock - Fesurf | © Adobe Stock - Heiko Zahn | © Adobe Stock - Puntostudiofoto Lda | © Adobe Stock - Pure life pictures | © Adobe Stock - Reindesign-sn | © Adobe Stock - S. Hermann | © Adobe Stock - Yasonia | © Agence Camelion - H. Hote | © Air N. Bouyssi | © Anjou Navigation | © ARPT Atejejo | © Atelier Bos | © Atout France - A. Blondiaux | © B. Cowling | © Bengoesplaces | © BECTourisme - A. Doire | © C. Richters | © CDT35 - M. Quincy | © CDT47 | © Charente Tourisme - S. Laval | © Château du Plessis Bourré | © CK Mariot Photography | © CMN Paris - P. Berthé | © Coteaux du Languedoc | © CRT Franche Comté | © CRT Franche Comté - J. Thiebaut | © CRT Franche-Comté - M. Joly | © CRT Midi Pyrénées - D. Viet | © CRTB - A. Lamoureux | © CRTB - E. Berthier | © D. Malzy | © D. Maugendre | © David de Miguel Herrero | © Dina | © Drone Images Solutions | © F. Paulussen | © Fotolia | © Fotolia - Afanasiá | © Fotolia - C. Calcagno | © Fotolia - E. Schittenhelm | © Fotolia - Fred34560 | © Fotolia - Kanuaq | © Fotolia - Kirsty Pargeter | © Fotolia - L. Andronov | © Fotolia - P. Bosseboeuf | © Fotolia - S. Weis | © Fotolia - Strikker | © Fotolia - Westfotos.de | © France Mag / Howorth | © G. Huet | © JAG Images - Tour Carbonniere | © Jowi Vermaal | © Les conteurs - destination Angers | © Lot Tourisme - C. Novello | © Lot tourisme - C. Seguy | © Lot Tourisme - D. Viet | © Luchtfoto | © J. Barna - Bliá Photography | © J. Laliaux | © J.J. Bernier | © JAG Images - Tour Carbonniere | © Jowi Vermaal | © Les conteurs - destination Angers | © Lot Tourisme - C. Novello | © Lot tourisme - C. Seguy | © Lot Tourisme - D. Viet | © Luchtfoto - Ph. Benoist | © O. Friedrich | © OT - S. Laval | © OT Cahors | © OT Saintes | © P. Beltrami - Mayenne Tourisme | © P. De Rexel | © P. Mielcarek | © P. Pierrard | © P. Sahuquet | © Pat on Stock | © Picknick | © R. Ulrich | © S. Gaudard | © S. Godin | © S. Golub | © S. Ouzouloff | © Sarreguemines Tourisme - T. Grun | © Seenland | © Smalltalk Mag & Webzine | © SMCG - S. Baudouin | © Vallée de la Sarthe | © Ville d'Auxerre - J. Laliaux | © Ville de Dole | © Ville de Laval | © Ville du Mans - Gilles Moussé | © VMK Cindy | © Voyage à Nantes | © Wallibi Sud-Ouest | © www.scharmuetzelsee.de | © Y. Goux | © Pozitivo-Digital | © AdobeStock | © Gopro|simontrkaadventures | © Woudrichem Shutterstock.

FUN FOR ALL **ON THE WATERWAYS!**



SOUVENIRS

MEMORIES - ERINNERUNGEN
RECUERDOS - MINDER
RICORDI - LEMBRANÇAS
HERINNERINGEN - EMLÉKEK



CAMARGUE

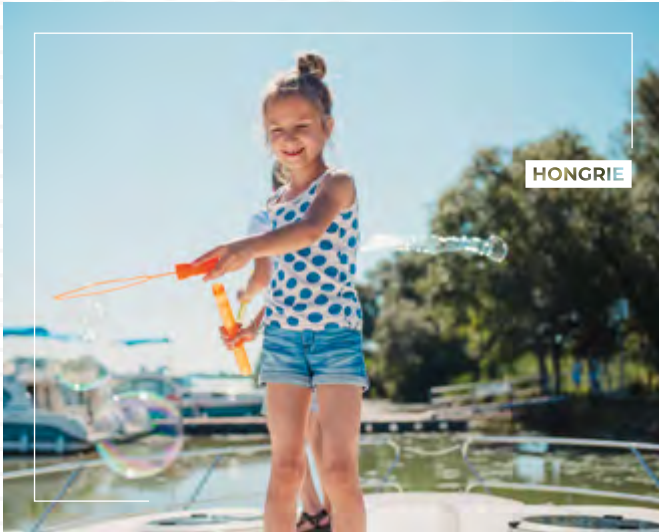

HONGRIE



CANAL DU MIDI



PORTUGAL



FRANCHE-COMTÉ

HOLIDAYS **EVERYONE WILL LOVE...**



Whether your crew is a couple or family and/or group of friends, new to boating or experienced sailors, we're sure to have a boat in the Nicols fleet to suit and a destination packed with places to visit and activities to enjoy.



FOR FAMILIES

A Nicols cruise is a great way to create special memories with your family.

These unforgettable trips on the waterways are enjoyed by everyone no matter how old you are.

Escape from the hustle and bustle of everyday life and enjoy a slower pace...

Whether it's a short weekend break with your friends or a longer family holiday we're sure you'll love everything about boating holidays and life on the canals and rivers.



FOR COUPLES

Enjoy a relaxing and romantic getaway by booking a boating holiday.

A boating holiday is a great idea for a romantic break. Nicols have a choice of smaller boats perfect for a couple to enjoy a relaxing and peaceful escape.



FOR OLDER CREWS

With a taste for discovery our older crews love the idea of a more unusual type of holiday and trying something completely new. Travelling by boat shows a region from a completely new perspective - all boats offer the best comfort and safety for peace of mind cruising. Start your adventure today!



WITH FRIENDS

Boating holidays are a great idea for a large group adventure. Simply hire a few boats and create a mini fleet for a fun and flexible break off of the beaten track.

Why not book for a birthday celebration or a get together with friends and family.

Choose from a weekend trip, a short break or a longer holiday.

GIFT CARDS **ALSO AVAILABLE!**

Looking for a great gift idea? Treat family or friends to a self drive boating break on one of our Nicols® boats. No previous boating experience needed!

Contact us for more information.



GET READY TO ENJOY THE WATERWAYS



BEFORE YOU LEAVE HOME

We will send you a complete set of documents including:

- **Captain's handbook:** preparation and advice for a trouble-free cruise from start to finish.
- **Navigation chart (if ordered):** vital for a well-organised cruise. On it you'll find the location of locks, water fill-up points, places of interest, etc... Remember to order one when booking.
- **Base location map:** instructions for locating your departure base easily.
- **Inventory:** list of all interior and exterior equipment.
- **Navigation instruction:** video giving advice for the navigation and security instructions to live aboard your cruiser.



YOUR LUGGAGE

Holdalls are recommended - they are easy to stow away. Suitcases do take up far more space on board, so perhaps unpack them and leave in the boot of your car. Take with you comfortable non slip shoes so that you can move on the deck without danger (tennis or baskets).

Don't forget sun glasses and sun creams, hats, gloves... and your camera!



WATERWAYS GUIDES

A comprehensive guide is vital for planning your cruise. It provides detailed information of the waterways on which you will navigate highlighting **useful information** such as the location of locks, quays, water fill-up points in addition to **tourist information** such as places to visit and their opening hours, market days, good restaurants and much more. We recommend you order your waterways guide at the same time as booking so that you receive it with the other cruise documentation you will be sent. This means you will have plenty of time to plan your journey in advance.

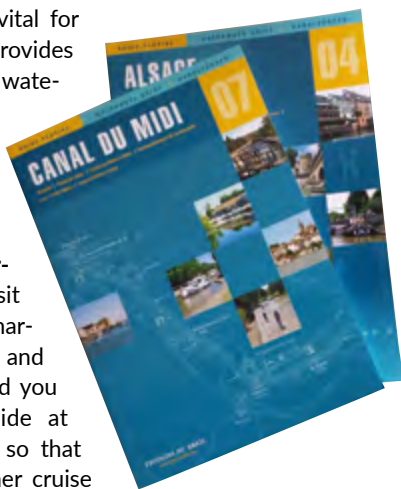

ON ARRIVAL AT THE BASE

Free public parking is available at all of our bases. Alternatively, at a supplementary cost, you can park your vehicle in a secure area or garage. Generally these facilities are unattended. A few formalities will need to be attended to whilst other members of the group load your luggage or perhaps go off to do some basic shopping to get you through your first day. One of our technicians will come aboard with you to show you how to operate your boat. Whenever possible he will be with you when you negotiate your first lock. You'll soon see that navigation is child's play. Now it's time to cast off !



AT THE END OF YOUR CRUISE

Remember to return the boat on time!

- **4-5 PM** for a weekend cruise,
- **8-9 AM** for longer cruises.

The personnel at the base can supply you with necessary materials to give the boat a good clean.



NAVIGATION IS EASY!

Our boats are easy to operate with either just one inside steering position or a second rooftop position to navigate under the sun with a panoramic view.

You will discover **simple controls that are easy to use**: the wheel, a gear lever and a few instruments on the dashboard. Don't worry if you've never been on a boat before - we'll show you everything you need to know before you set off. You'll be taken out on the water and given a hands on demonstration of everything from how to go through locks to tying up at the water's edge.

WARNING: the minimum age to take the helm of a boat is 16 years old but they must remain under the captain's (an adult!) responsibility.



CANAL OR RIVER?

Most of the waterways in our brochure are generally wide and nontidal making them easy to navigate. Depending on your chosen departure base you may cruise on both canals and rivers.

Rivers, where natural, are more susceptible to the possibility of flooding compared to the manmade canals - especially in Spring and Autumn.

Some navigation restrictions may occur as a result of this flooding and for your own safety we may change your departure base or restrict cruising to the canal sections only, rather than cancelling your cruise completely. Please make enquiries about the state of the waterways before leaving on your cruise.



WHERE TO STOP

During your cruise **you're free to stop wherever you like...**being careful not to disrupt the countryside and wildlife (or encroach on private property!) simply moor up and step ashore.

Day-by-day you'll discover new surroundings and sights as you travel at your own pace through beautiful countryside - a wonderful way to enjoy ever-changing scenery and the great outdoors.

If on the other hand you prefer the hustle and bustle of the towns and villages you pass on route then take advantage of the purpose-built ports and mooring sites. Some are free while others are available at a small charge (this varies depending on the size of the boat and whether there are power charging points). We estimate charges to be between 10€ to 50€. These comfortable and serviced areas will provide easy access to the town.



LOCKS



- **Will I have to pay?** Passage through locks and bridges is free.
- **Are they automatic?** Most locks are automatic and operated by a lock keeper who may ask you to help them, whilst others are manual. In the Charente and the Lot the locks are all operated by you and your crew, thus you are not restricted by timetables.
- **Are there days of closing?** Most locks are automatic and operated by a lock keeper who will be happy to help you. In general, lock keepers do not work on Bank Holidays : Example in France: 1st May, 14th July and 1st November. For a list of regions concerned please contact us.

WARNING

the information provided in this document is not contractual. Characteristics may vary depending on the boats and the areas where you'll navigate.

EVEN MORE **TO ENJOY...**



Make your holiday extra special! NICOLS® offers the following extras...
To guarantee these optional extras we recommend booking them as soon as possible.





BICYCLES

Bikes are available to hire from all of our bases and provide extra flexibility for exploring the area where you've moored, little villages, places of interest or simply for going to buy your daily bread.

A helmet is mandatory for children under 12 years of age: please remember to bring your equipment.



FISHING

Your boat is a great vantage point for fishing from. You can fish in the canals and rivers providing you hold a fishing licence. These can be purchased from local fishing tackle shops or on the web (www.cartedepeche.fr). As a guide, a 7-day licence for fishing will cost around 32 € in France and 40 € in Germany. In Portugal it's a one off cost of 25 € regardless of the length of your holiday.



BARBECUE

Hire all of the equipment you'll need to enjoy a barbecue, then simply pick up your food fresh from the many mooring places you'll find on route. Take it on board with you...most of our bases even offer rental of gas bottles. As with all barbecues please be careful and familiarise yourself with all the equipment before departure.



WiFi

Whether it's your tablet, laptop or mobile phone... stay connected during your cruise! Most of our bases offer a Wifi service that will allow you to connect multiple devices simultaneously*. For more information please contact us.

(*subject to the quality of network coverage. This varies by region).



THE SWIMMING POOL: A NICOLS® EXCLUSIVE®

The on-board pool! Discover the pleasures of on-board bathing by adding one of our fantastic heated splash pools – simply tow it along with your boat. Suitable for the Estivale, Confort and Sedan (except Fly range, N800, Primo® and R920) ranges. N.B. : for boats of 13 m length and more a pleasure boat licence is necessary due to the total length of the boat plus pool.

TECHNICAL DESCRIPTION:

Dimensions: 2,55 m x 3,10 m. Capacity: 700 litres, suitable for 3 people. Terrace with double safety rails. Converts into a larger terrace with two sliding covers.

Available in: **Alsace, Aquitaine, Charente, Franche-Comté, Midi.**



DECK MATTRESS

Enjoy additional onboard comfort with our deck mattress. Foldable and easy to store, the mattress is great for relaxing on the roof terrace or front deck of your Nicols® boat.



ANIMALS

Pets are welcome onboard. A supplement of 40 € will be requested when you depart the base. Don't forget to bring their belongings (feeding bowl, bedding/blankets etc) and when travelling ensure that they remain safe and cannot cause any harm or damage.



ALL INCLUSIVE

The Nicols® **ALL INCLUSIVE** option makes holiday planning easy with everything you need and more for a wonderful boating holiday. Let us do the hard work while you sit back and relax. The all inclusive option includes: boat fuel + cleaning fee + 2 bikes + a waterways guide + 1 set of linen per person + 1 set of kitchen linen. For more information please contact us.

OUR THEMED CRUISES



NICOLS® new themed cruises will help you choose the best suited itinerary to match your interests.



FOOD & WINE

Vineyards, wineries, tasting venues, restaurants offering prestigious local specialties and local produce tastings...



HISTORY & HERITAGE

Castles, religious buildings, classified sites, free tours to discover places of interest or hosted tours from the experts...

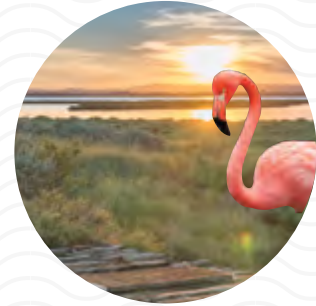

FLORA & FAUNA

Areas of natural beauty for fauna, flora and wildlife. Free tours to discover places of interest or hosted tours from the experts...

GOLF

Mix your hobby of golf with a boating holiday. Some golf courses can even be found within walking distance of the waterways!

SWIMMING & BATHING

Natural and artificial lakes, easy beach access close to the river/canal, swimming pools and waterparks...













FISHING

In the canals, rivers, lakes and ponds! A holiday on the water is a fisherman's dream holiday... whether an amateur or enthusiast. What will you catch?

FAMILY

Highlights any route with activities suitable for children and the whole family to enjoy. Zoo's, play areas, adventure parks and many more...

Look out for the appropriate symbols flagging the interests throughout the brochure...

	Gastronomie & œnologie		Archaeological site		Swimming		Marvelous flora & fauna, Zoo, Animal park		Hiking
	Vineyard area		Cave		Indoor pool		Golf		Train station
	Restaurant		Museum		Nautic activities		Cycle paths		Airport
	Historical heritage		Typical town centre		Boat lift Water slope Lock staircase		Viewing point		Family fun
	Religious heritage		Craft industry		Fishing		Pony trekking		

LET'S TAKE CARE OF THE ENVIRONMENT TOGETHER!



By hiring a canal boat you are choosing a holiday set at the heart of nature so we know that wildlife and the countryside is important to you. The quality of the environment in which you will be navigating in contributes greatly to the enjoyment of your holiday, so between us let's protect it together. Our small actions... can have big effects!

How Nicols is helping the environment:



Nicols is committed to the preservation of the Canal du Midi: as a patron, we are participating in the replanting of trees along the Canal du Midi.



In 2018, Nicols created the first fully electric powered canal boat in Europe. For 2022, Nicols is continuing to add 'green' boats to the fleet with a second electric powered boat (details on page 48).



In Portugal, the entire Nicols fleet is equipped with solar panels.

How you can help us protect nature:



When mooring, be careful not to damage the plant species around you.



Leave no trace of your visit: pick up your rubbish and dispose of it at the designated waste disposal services found on route. Also, try and think about sorting your waste – what might be able to be recycled?



When collecting your boat Nicols will offer you a welcome kit including biodegradable cleaning products. If however you bring your own cleaning and hygiene products, you too should choose biodegradable products.

Together, let's act as protectors of the environment.



MALESTROIT

BRITTANY

 Canal de Nantes à Brest - La Vilaine - L'Erdre

At the crossroads of l'Erdre, la Vilaine and the Nantes to Brest Canal, discover the charms of Inland Brittany: waterways devoted entirely to pleasure cruising, its traditions, its seafood, delicious crepes and traditional cider!

FROM GLÉNAC AND SUCÉ-SUR-ERDRE

Explore a land of magic and mystery, rich in colour and traditions with a boating holiday in Brittany cruising the canal from Nantes to Brest. Enjoy historical treasures and remarkable natural sites: **Josselin, with its magnificent castle** reflected in the water ; **Malestroit and its 15th century houses** ; the craftsman village of Gacilly ; Redon founded in 832 or Blain (traditional popular arts museum)...

The river Vilaine takes you to Rennes, the capital of Brittany, and on to Dinan and the surrounded ramparts dating back to the thirteenth century.

Following the Erdre you'll pass fantastic golf courses. Count **17 castles within just 15km of waterways on this stretch!** In two hours of locks free cruising you'll be at the heart of the city of Nantes and all its treasures: Cathedral St Pierre, Chateau des Ducs de Bretagne, Pommeraye passage, Museum of Fine Arts, the Machines of the Isle... to name just a few!



JOSSELIN



DON'T MISS

	LA GACILLY: exhibition of 30 years of crafts JOSSELIN: painting, sculpture, ceramics, leather, jewellery LA ROCHE-BERNARD: art workshops in the old districts
	Castles of the Dukes of Brittany (Nantes), castles at Blain and Josselin, castles dotted along the river Erdre Small towns with character: Malestroit, La Roche-Bernard, Josselin, Rochefort-en-Terre
	ÎLE AUX PIES: adventure trail GUENROUËT: leisure park including mini-golf and waterslides NANTES: the "Machines de l'Île" art project



→ NANTES
Castle of the Dukes of Brittany



→ LA ROCHE-BERNARD
Artist



→ LA GACILLY
Photo festival



↑ RENNES



→ L'ERDRE



- Nicols base
- Navigation limit
- Dam
- See p. 10
- Locks are open all season

↓ NANTES
"Machines de l'Île"



GLÉNAC

Redon (12 km), Rennes (70 km), Nantes (90 km).

- A81 (Paris-Rennes - 350 km).
- TGV Redon (12 km), TGV Rennes (65 km), TGV Nantes (105 km).
- Nantes (105 km), Rennes (71 km).

SUCÉ-SUR-ERDRE

Nantes (20 km), Rennes (115 km).

- A11 (Paris-Nantes - 380 km), N 23 - Nantes-Est.
- Nantes (20 km), TGV Paris-Nantes (2h15).
- Paris-Orly (375 km), Nantes (30 km).

Available fleet page 45 - Boat descriptions pages 46 to 58

DURATION	OUR CRUISE SUGGESTIONS	KM	LOCKS	HOURS
2 DAY WEEKEND	A Glénac > Malestroit > Glénac	59	10	10h
	B Glénac > La Roche-Bernard > Glénac	90	2	12h30
	C Glénac > Guenrouët > Glénac	74	4	11h30
SHORT BREAK	A Glénac > Josselin > Glénac	109	30	22h
	B Glénac > Blain > Glénac	118	14	21h30
SHORT BREAK (One way)	A Glénac > Sucé/Erdre	93	17	20h30
1 WEEK	A Glénac > Josselin > Rohan > Glénac	158	62	39h
	B Glénac > Rennes > Glénac	184	24	33h
1 WEEK (One way)	A Glénac > Nantes > Sucé/Erdre	136	17	27h
10/11 DAYS	A Glénac > Nantes > La Roche-Bernard > Glénac	234	34	48h
2 WEEKS	A Glénac > Dinan > Glénac	362	120	74h

Available fleet page 45 - Boat descriptions pages 46 to 58

DURATION	OUR CRUISE SUGGESTIONS	KM	LOCKS	HOURS
2 DAY WEEKEND	A Sucé/Erdre > Blain > Sucé/Erdre	70	20	14h
	B Sucé/Erdre > Nantes > Bout de Bois > Sucé/Erdre	76	12	15h
SHORT BREAK	A Sucé/Erdre > Guenrouët > Sucé-sur-Erdre	114	30	23h
SHORT BREAK (One way)	A Sucé/Erdre > Glénac	93	17	20h30
1 WEEK	A Sucé/Erdre > La Gacilly > Sucé/Erdre	194	32	35h
	B Sucé/Erdre > La Roche-Bernard > Sucé/Erdre	228	32	36h
	C Sucé/Erdre > Messac > Sucé/Erdre	240	34	41h
1 WEEK (One way)	A Sucé/Erdre > Nantes > Glénac	136	17	27h
10/11 DAYS	A Sucé/Erdre > Malestroit > Sucé-sur-Erdre	218	40	42h
	B Sucé/Erdre > Redon > Rennes > Sucé/Erdre	334	58	60h
2 WEEKS	A Sucé/Erdre > Redon > Josselin > Sucé/Erdre	268	60	55h



GREZ-NEUVILLE

ANJOU

 La Mayenne - La Sarthe - L'Oudon

The beautiful and welcoming valleys of Anjou are just 2 hours and 30 minutes from Paris. A cruise on the Sarthe and Mayenne rivers takes you to the heart of the region's rich heritage with numerous castles, mills and character villages to explore. A boating holiday in this area a great option for those new to the waterways.

FROM **GREZ-NEUVILLE**

Dotted along the banks of the Mayenne river are numerous places to visit such as the Lion d'Angers equestrian centre, the millennial city of Château-Gontier, the Port-Salut abbey at Entrammes and the historical cities of Laval and King René's Angers. Cycling enthusiasts will appreciate the excellent 'EuroVelo' towpath that runs along the river, specifically geared to cyclists and an award winner in 2017. Another hidden gem is the small and calm Oudon river that flows into the Mayenne close to Grez-Neuville and is therefore a must see.



LA MAYENNE

FROM **LAVAL**

See more with a one-way cruise from Laval to Sablé-sur-Sarthe or Laval to Grez-Neuville. This route is perfect for nature lovers taking in the high valleys of Anjou (a Natura 2000 nature protection area) with visits to great places such as Laval, Château-Gontier, Angers and Sablé-sur-Sarthe.

FROM **SABLÉ-SUR-SARTHE**

Discover the pretty Sarthe river and the surrounding delights. Meandering through verdant countryside dotted with picturesque villages. There are very few locks along its reaches, so it's ideal for beginners. Don't miss the most elegant castle of Plessis Bourré, the imposing Benedictine Abbey of Solesmes, Malicorne, capital of artistic porcelain and the older part of Le Mans town... Also enjoy local specialities such as rillettes du Mans!



SOLESMES - The abbey

DON'T MISS

	ANGERS: the castle of King René LE MANS: the historic quarter of the Plantagenet City SOLESMES: the Benedictine Abbey
	ÉCOUFLANT: Parc Anjou adventure park JAILLE-SUR-YVON: tree top trek SPAY: wake boarding watersports centre
	ANGERS: plant life theme park "Terra Botanica" ASNIÈRE: botanical garden with mosaic garden SPAY ET CHÂTEAU-GONTIER: animal parks

→ ANGERS
Maison d'Adam

→ LAVAL



- Nicols base
- Navigation limit
- See p. 10
- Locks are open all season



SABLÉ-SUR-SARTHE

Paris (250 km), Rennes (128 km), Angers (65 km), Le Mans (50 km).
 A11 (Paris-Sablé 260 km), 10 (13 km).
 Sablé 800 m, TGV Paris-Sablé (1h20).
 TGV Roissy CDG-Sablé (2h20), Roissy CDG (285 km), Paris-Orly (250 km), Nantes-Atlantique (160 km).

GREZ-NEUVILLE

Angers (25 km).
 A11 (Paris-Angers 300 km) 17.
 TGV Angers (25 km).
 Paris-Orly (305 km), Nantes-Atlantique (110 km).

Available fleet page 45 - Boat descriptions pages 46 to 58

DURATION	OUR CRUISE SUGGESTIONS	KM	LOCKS	HOURS
2 DAY WEEKEND	A Sablé > Malicorne > Sablé	52	10	10h
	B Sablé > Châteauneuf-s.-Sarthe > Sablé	60	10	10h
SHORT BREAK	A Sablé > Angers > Sablé	120	12	18h
	B Sablé > Malicorne > Châteauneuf > Sablé	112	20	19h
SHORT BREAK (One way)	A Sablé > Angers > Grez	84	10	14h30
1 WEEK	A Sablé > Spay > Châteauneuf > Sablé	149	26	25h
	B Sablé > Angers > Grez > Sablé	168	20	29h
1 WEEK (One way)	A Sablé > Malicorne > Angers > Segré > Grez	175	27	28h
	B Sablé > Angers > Châteauneuf-Gontier > Grez	144	27	24h
10/11 DAYS	A Sablé > Angers > Sablé > Fillé > Sablé	234	30	40h

Available fleet page 45 - Boat descriptions pages 46 to 58

DURATION	OUR CRUISE SUGGESTIONS	KM	LOCKS	HOURS
2 DAY WEEKEND	A Grez > Château-Gontier > Grez	62	18	10h30
	B Grez > Daon > Segré > Grez	62	12	10h30
	C Grez > Angers > Grez	62	8	10h30
SHORT BREAK	A Grez > Entrammes > Grez	122	34	21h
	B Grez > Château-Gontier > Segré > Grez	96	24	18h
SHORT BREAK (One way)	A Grez > Segré > Laval	106	27	17h30
	B Grez > Montgiroux > Laval	110	35	20h
1 WEEK	A Grez > Laval > Segré > Grez	176	46	30h
	B Grez > Sablé > Malicorne > Grez	190	42	30h
1 WEEK (One way)	A Grez > Segré > Angers > Malicorne > Sablé	175	27	28h
	B Grez > Château-Gontier > Angers > Sablé	144	27	24h
10/11 DAYS	A Grez > Mayenne > Grez	210	84	44h

LAVAL

Paris (280 km), Rennes (75 km).
 Rennes : A81, 4, Paris : A11 / A81, 3
 TGV 800 m.
 Rennes (80 km).

DURATION	OUR CRUISE SUGGESTIONS	KM	LOCKS	HOURS
SHORT BREAK (One way)	A Laval > Segré > Grez	106	27	17h30
	B Laval > Montgiroux > Grez	110	35	20h
1 WEEK (One way)	A Laval > Angers > Sablé	146	31	28h

EVEN MORE COMFORT ON BOARD! The whole fleet benefit from 1 quay plug 220 Volts and electric toilet and one USB port per cabin.



SAINT-SIMEUX

CHARENTE



Enjoy a boating holiday on one of France's most beautiful rivers. Take in green countryside, crystal clear waters and fields of sunflowers whilst you cruise. The best bists : Locks operated by yourself so no restrictions on travel time ; Cognac and Pineau vineyards and tasting! Peaceful countryside and ancient Roman sites.

FROM SIREUIL



Large and winding, the river Charente quoted by François the 1st as “the most beautiful stream in the Kingdom”, runs through the ancient counties of “Langoumois” and “La Saintonge”.

For 171 km, from Angoulême to Rochefort, the Charente is regulated by 21 locks. The ancient vineyards cover the surrounding hills. Many cellars and distilleries will invite you to taste **the famous Cognac or delicious pineau des Charentes**. Along your cruise, you will find many villages and towns that are testimonies to a rich past such as Angoulême, Fleurac, Saint-Simeux, Châteauneuf, Saint-Simon, Bassac, Jarnac, Saint-Brice, Cognac, Saintes, Saint-Savinien, and Rochefort.

In the Charente area, the gastronomy based on seafood and local products, is waiting for you along the river with many of its restaurants preparing local specialities (“mouclade”, oysters, melon, meats, snails, cheese...). Fishermen will not be forgotten and will find plenty of brown trout, carp, pike, perche, and eels..







SIREUIL - Nicols® base



SAINTES - Arc Germanicus

DON'T MISS

	COGNAC: famous producers Hennessy, Martell, Baron Otard and museum of Cognac production JARNAC: famous producer Courvoisier LES AIREAUX: famous producers Maison Brillet and Pineau des Charentes
	Regional dishes such as melon charentais, mouclade, oysters and snails The many wines of Pays Charentais
	CHÂTEAUNEUF-SUR-CHARENTE AND L'ÎLE MADAME (JARNAC): Supervised beaches, Swimming possible everywhere in the Charente river
	Trout, carp, pike, perch, eels and many more!



→ Supervised beaches on the edge of Charente

La Rochelle

Legend:

-  Nicols base
-  Navigation limit
-  See p. 10
-  Locks are open all season



SIREUIL

Poitiers (130 km), Bordeaux (118 km), Angoulême (20 km).
A10 (Paris **N** 30 (Poitiers-Sud), A10 (Bordeaux **N** 39b (Barbezieux).
Angoulême (20 km), TGV Paris (2h20), Châteauneuf-s.-Charente (8 km).
La Rochelle-Laleu (145 km), Bordeaux-Mérignac (118 km), Angoulême-Champniers (30 km).

 Available fleet page 45 - Boat descriptions pages 46 to 58

DURATION	OUR CRUISE SUGGESTIONS	KM	LOCKS	HOURS
2 DAY WEEKEND	Sireuil > Jarnac > Sireuil	56	18	13h
SHORT BREAK	Sireuil > Chaniers > Sireuil	132	30	24h
	Sireuil > Saint-Savinien > Sireuil	198	30	32h
10/11 DAYS	Sireuil > Angoulême > Sireuil > Saint-Savinien > Sireuil	232	40	40h
2 WEEKS	Sireuil > Rochefort > Sireuil	252	32	40h

→ ABBAYE-AUX-DAMES - musical carousel



→ JARNAC



→ Stroll through the Charentais vineyards



→ COGNAC - Tours Saint-Jacques

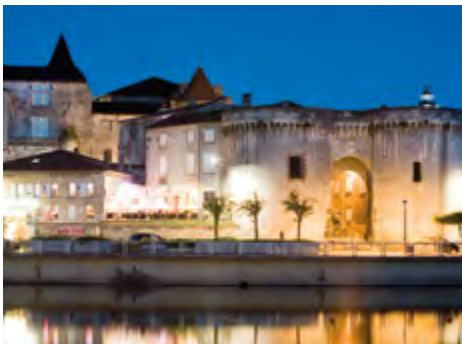

→ ANGOULÊME - City of comics



→ Pineau and Charentais melon



Cruise suggestions: non contractual information, subject to change.



CAHORS - Valentré bridge

LOT



The cliffs of limestone, the picturesque villages, the gastronomy:
stuffed foie gras, goose confit, Cahors wine...

FROM CAHORS



Cast off from Cahors! This medieval town with its renowned vineyard is an ideal starting point to begin your cruise in the heart of the Lot valley.

A succession of **cliffs and caves await** you around the tree-lined curves of the Lot. A 74 km river for your complete pleasure!

17 manual locks, to operate yourself as in former times. The old villages of Quercy with their narrow alleys and mossy, red roofs, the famous Valentré bridge of Cahors, the cliffs of Bouziès, Saint-Cirq-Lapopie village overlooking the valley, add to the charm of this navigation.



SAINT-CIRQ-LAPIOPE





BOUZIÈS - Castle of the English

 **DON'T MISS**

	SAINT-CIRQ-LAPOPIE: an interesting medieval village CAHORS: the Valentré bridge (a UNESCO site) BOUZIÈS: the towpath carved into the rocks, the painted cave of Pech Merle, the 20,000 year old Castle of Cenevières
	Wines of Cahors: Château Saint-Sernin at Parnac, Le Domaine Lagarrigue at Lamagdeleine and also Le domaine Dols in Bouziès
	Regional products: truffled foie gras, goose confit, walnut cake
	Bathing in Cahors and Saint-Cirq-Lapopie Swimming is also possible in the river Lot!

 **CAHORS**

Montauban (60 km), Brive (100 km), Toulouse (115 km).

 A20, Paris-Toulouse,  57 Cahors-centre (15 km)
ou  58 Cahors-centre (15 km)

 Cahors (1 km), Montauban (65 km).

 Toulouse-Blagnac (110 km), Brive Vallée de la Dordogne (85 km).

 Available fleet page 45 - Boat descriptions pages 46 to 58

DURATION	OUR CRUISE SUGGESTIONS	KM	LOCKS	HOURS
1 WEEK	A Cahors > Luzech > Larnagol > Cahors	148	34	30h
	B Cahors > Luzech > St-Cirq-Lapopie > Cahors	125	28	22h
MINI-WEEK*	A Cahors > St Cirq-Lapopie > Cahors	70	22	15h







*on request

Warning: we recommend that you've had some previous boating experience if cruising on the river Lot.

→ Castle of MERCUÈS



← Pech Merle caves

-  Nicols base
-  Navigation limit
-    See p. 10
-  Locks are open all season



↑ The CHAMIZO WALL MURAL the largest mural of contemporary art in Europe at 120m long and 6m high!

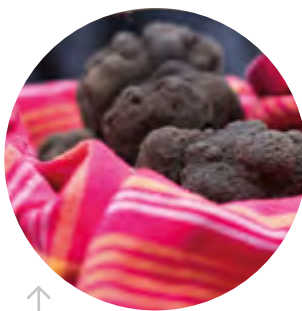

↑ Truffles, the local speciality

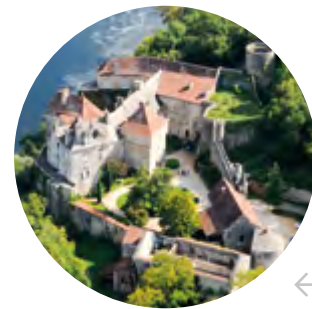

← Castle of CÉNEVIÈRES

→ CAHORS



→ Swimming in the river





NÉRAC

AQUITAINE

 La Baïse - Le Canal de Garonne

Possibility to cruise both on canal and river, automatic locks, natural beauty and cultural inheritance, local specialities : Armagnac, duck breast, Agen prunes, Buzet wines...

FROM BUZET-SUR-BAÏSE



A choice of memorable itineraries in the land of King Henri IV and d'Artagnan the Musketeer!

The River Baïse*, mysterious and bewitching, meandering its way past bastide towns, abbeys and castles of Gascony, visiting Vianne, Nérac and Condom.

The garonne Canal flows quietly under the plane trees towards the Aqueduct of Agen, the Cloister of Moissac, "the Water Slope" of Montech and through the historic town of Toulouse.

Towards Bordeaux, discover the Rembrandt of Le Mas d'Agenais, the promontory of Meilhan and the charming village of Fontet.

*Please note: navigation on the river Baïse may be subject to change. See the 'Canal or River' section on page 7.

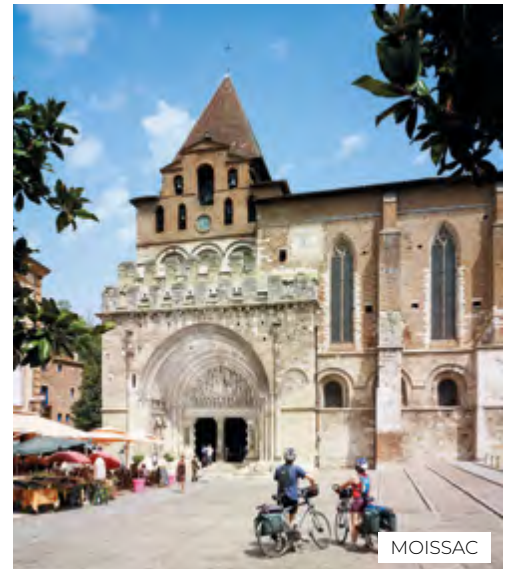

MOISSAC

DON'T MISS

	<p>NÉRAC: Castle of King Henri IV (16th century) VIANNE: fortified country house (12th century) FLARAN: Cistercienne Abbey (12th century) CONDOM: Cathedral and Cloister (14th century) on the pilgrimage route to Compostelle - MOISSAC: Abbey and Cloister (12th century) on the pilgrimage route to Compostelle - AGEN: canal bridge (19th century) at 530 metres long</p>
	<p>Wines of Buzet: Cave-Coopérative in Buzet, Château Frandat in Nérac Armagnac: Maison Ryst-Dupeyron and the Armagnac museum in Condom Floc de Gascogne: Château de Cassaigne</p>
	<p>Numerous gourmet restaurants Foie gras of duck: at the farm and duck kitchen of Lafitte à Montgaillard Pruneau d'Agen: Roques farm in Montesquieu... Melon de Nérac (in the markets) - The unconventional strawberry and tomato jam of Marmande (in the markets)</p>
	<p>SWIMMING POOLS: Lud'o Parc in Nérac, Aqualand in Agen, Condom and Moncrabeau BEACHES: Damazan and Fontet lakes, supervised beaches in summer FAMILY ATTRACTIONS: Walibi in Agen, Agrip'Aventure (tree-top assault course) in Montech, Albret Tourism Railway between Nérac and Mézin</p>

BUZET-SUR-BAÏSE

Bordeaux (110 km), Agen (30 km), Toulouse (150 km).
 A62, Bordeaux-Toulouse, **N76** Aiguillon (5 km).
 Aiguillon (5 km), Agen (30 km), TGV Paris-Agen (4h).
 Bordeaux-Mérignac (115 km), Toulouse-Blagnac (150 km).





 Available fleet page 45 - Boat descriptions pages 46 to 58

DURATION	OUR CRUISE SUGGESTIONS	KM	LOCKS	HOURS
2 DAY WEEKEND	A (Baïse) Buzet > Nérac > Buzet	42	14	10h
	B (Canal) Buzet > Agen > Buzet	56	14	10h
SHORT BREAK	A (Baïse) Buzet > Moncrabeau > Buzet	70	28	17h
	B (Canal) Buzet > Fontet > Buzet	98	16	17h
	C (Canal) Buzet > Valence d'Agen > Buzet	108	20	18h
1 WEEK	A (Baïse) Buzet > Valence-s.-Baïse > Buzet	112	40	28h
	B (Canal) Buzet > Montech > Buzet	184	58	38h
10/11 DAYS	A (Canal & Baïse) Buzet > Fontet > Valence-s.-Baïse > Buzet	220	54	46h

Cruise suggestions: non contractual information, subject to change.



← AGEN Attractions family 

-  Nicols base
-  Navigation limit
-  See p. 10
-  Canal de Garonne : locks closed on 1st May
-  The Baïse: locks are open all season

↑ Barbaste Mill NÉRAC

→ CONDOM



→ AGEN - Canal bridge



→ NÉRAC





CARCASSONNE

MIDI

 Canal du Midi - Canal de la Robine - Canal du Rhône à Sète

Classified by UNESCO as a World Heritage Site, the Canal du Midi links the Atlantic with the Mediterranean and takes you through sun drenched vineyards and to numerous villages and canal side restaurants. The best bits: plenty of sunshine, numerous historical sites to visit, and excellent Languedoc wines from waterside vineyards.

FROM **LE SOMAIL**



From the charming small port of Le Somail, cruise away to discover the Canal du Midi in the direction of Carcassonne or if your cruising time permits down to Narbonne close to the Mediterranean Sea. You will cruise on the largest pound of France (52 km without any locks) up to the Fonseranes staircase, situated close to the historical city of Béziers.

A few kilometres more and you arrive, via Agde, to the huge Etang de Thau - renowned for its oyster beds...

FROM **PORT-LAURAGAIS**



Cast off from our base in Port-Lauragais and sail west towards **Toulouse, named the "pink city"** because of its red brick buildings, rich with points of interest for tourists - Heritage Capitol museum, city of Space to name a couple.

To the East a must stop is **Castelnaudary to try its delicious cassoulet**, a local gastronomic specialty, before cruising on to the medieval city of Carcassonne. The streets of Trebes, whose origin date back to 4500BC, await you before reaching Homps and its man-made beaches.



DON'T MISS

	WINE APPELLATIONS: Minervois, Corbières, Limoux, Coteaux du Languedoc, Saint-Chinian VENTENAC-EN-MINERVOIS: wine museum MARSEILLAN: cellars of Noilly Prat Numerous cellars at Marseillette, Colombiers, Puichéric, Vias and Capestang
	ADVENTURE PARKS: outdoor adventure park in Portiragnes and the indoor Europark in Vias WILDLIFE PARKS: Australian park in Carcassonne and African reserve of Sigean near Port la Robine
	LAKE WITH BEACH & WATERSPORTS: Etang de Jouarres near Homps SWIMMING POOLS: Trèbes and Castelnaudary BEACHES: Vias (1 km), Port-la-Nouvelle (2 km) Portiragnes, Port Cassafières and Agde (4 km)



→ TOULOUSE
Capitole square



→ Minervois vineyard

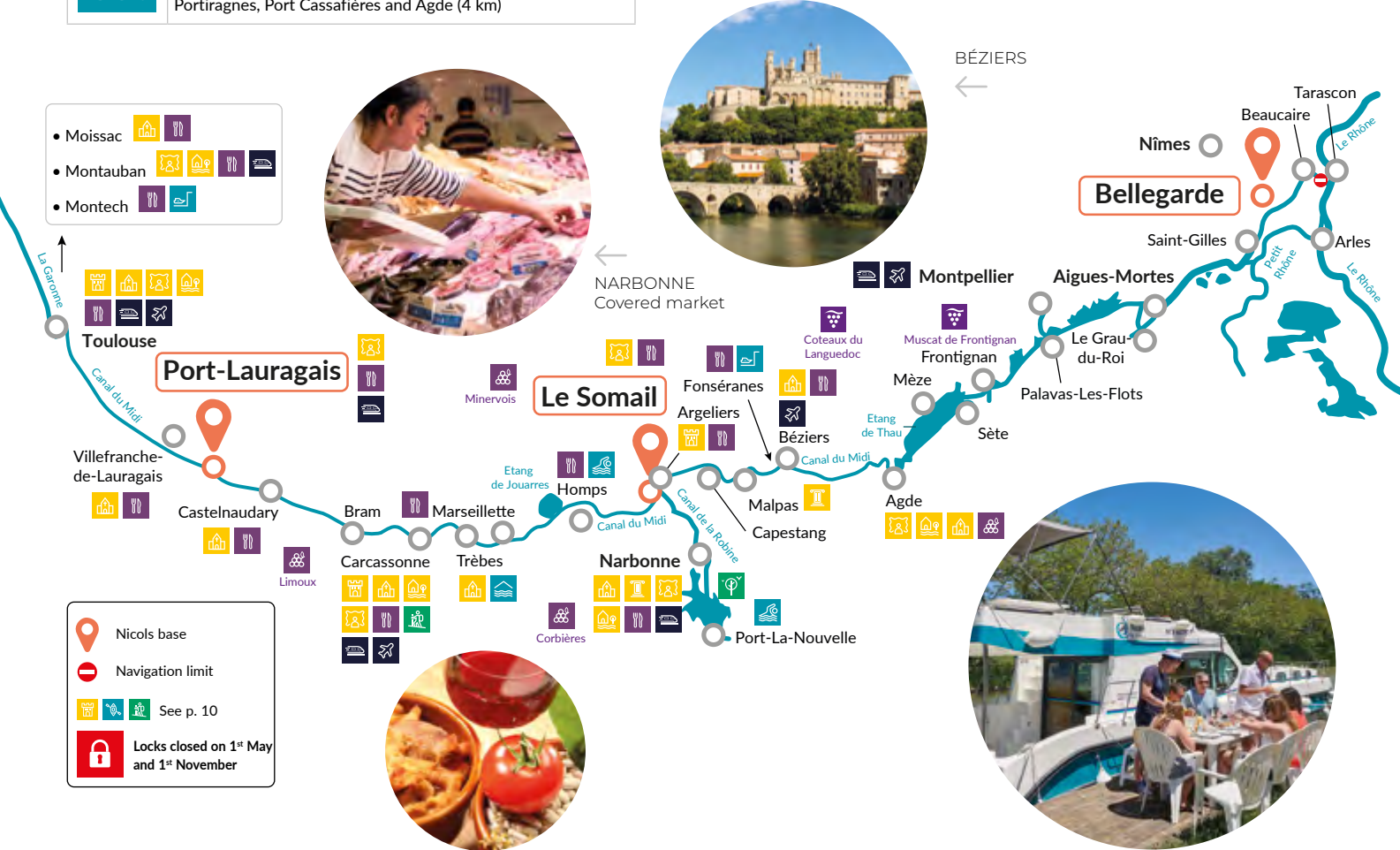

LE SOMAIL

Narbonne (18 km), Béziers (40 km), Carcassonne (50 km).

A61, A9, Paris (770 km).

TGV Béziers & Narbonne.

Béziers (35 km), Carcassonne (56 km), Montpellier (150 km), Toulouse (148 km).

PORT-LAURAGAIS

Avignonet-Lauragais (2,5 km).

Toulouse (56 km) A61 - 20, Narbonne (116 km) A61 - 21.

TGV Toulouse Matabiau (45km), TER Avignonet Lauragais (2,5 km)

Toulouse-Blagnac (56 km), Carcassonne-Salvaza (55 km).

Available fleet page 45 - Boat descriptions pages 46 to 58

DURATION	OUR CRUISE SUGGESTIONS	KM	LOCKS	HOURS
2 DAY WEEKEND	A Le Somail > Fonsérannes > Le Somail	84	-	12h
	B Le Somail > Homps > Le Somail	44	12	10h
SHORT BREAK	A Le Somail > Narbonne / Fonsérannes > Le Somail	113	22	23h30
	B Le Somail > Port-La Nouvelle > Le Somail	78	26	17h
	C Le Somail > Marseillette > Le Somail	80	34	22h
1 WEEK	A Le Somail > Trèbes > Le Somail	98	40	26h
	B Le Somail > Carcassonne > Le Somail	124	54	33h
	C Le Somail > Agde > Le Somail	130	24	25h
1 WEEK (One way)	A Le Somail > Port-Lauragais	116	60	34h
	B Le Somail > Bellegarde	174	14	31h
10/11 DAYS	A Le Somail > Bram > Le Somail	172	66	45h

Available fleet page 45 - Boat descriptions pages 46 to 58

DURATION	OUR CRUISE SUGGESTIONS	KM	LOCKS	HOURS
2 DAY WEEKEND	A Port-Lauragais > Castelnaudary > Port-Lauragais	30	18	9h30
	B Port-Lauragais > Toulouse > Port-Lauragais	90	28	22h
SHORT BREAK	A Port-Lauragais > Bram > Port-Lauragais	60	54	24h
	B Port-Lauragais > Carcassonne > Trèbes > Port-Lauragais	134	80	42h
1 WEEK	A Port-Lauragais > Carcassonne > Le Somail	116	60	34h
10/11 DAYS	A Port-Lauragais > Marseillette > Port-Lauragais	152	86	47h



AIGUES-MORTES

CAMARGUE

 Canal du Rhône à Sète - Étang de Thau - Canal du Midi

The Camargue's close proximity to the Mediterranean means that you will also enjoy everything that you get from a holiday by the coast. Other highlights of cruising in the region are the south of France gastronomy, getting to explore one of Europe's largest nature reserves and lock-free cruising which is perfect for boating beginners!

FROM BELLEGARDE

Discover the Etang de Thau and the Camargue marshlands, a formidable 85,000 hectare nature reserve where the richest and most picturesque flora and fauna in Europe await you. Set in a remarkable backdrop of fortified towns, castles and historic remnants of the time of the First Crusades, you will also be seduced by the southern cuisine including the famous oysters from Bouzigues, the fine wines of Costières de Nîmes or the Muscat de Frontignan.

Enjoy the pleasures of swimming in the Mediterranean at Grau du Roi, Palavas-les-Flots, La Grande Motte or even Carnon...; go on a horseback ride in the "herds" of Franquevaux or accompany the guardians in the sorting of bulls; do not miss a visit to the Salins du Midi which has surrounded the city of Aigues-Mortes since the Middle Ages; discover the treasures of the abbey of Maguelone or visit Saint-Gilles on the pathways of Saint-Jacques-de-Compostelle. Another must-see is the city of Sète, a maritime city of character which sits at the opening of the lake of Thau and onwards towards the Canal du Midi...



DON'T MISS

	WINE APPELLATIONS: Costières de Nîmes, muscat de Frontignan, Sables wines, Picpoul and rice beer!... GALLICIAN: wine cellar AIGUES-MORTES: wine cellar "Les Remparts"
	MEDITERRANEAN CUISINE AND LOCAL PRODUCTS: rice and salt of the Camargue, olive oils, Fougasse of Aigues-Mortes, asparagus, fish and seafood
	GRAU DU ROI: Aquarium, mini golf, Babyland adventure park AIGUES MORTES: 'Les Petits Bouts' adventure park, Train du Colorado (a 1/24 scale model railway), the 'Templar treasure hunt' around the city
	Flamingos, horses and bulls of the Camargue Wildlife observation: Scamandre discovery centre, the La Marette pond near our Aigues-Mortes base!

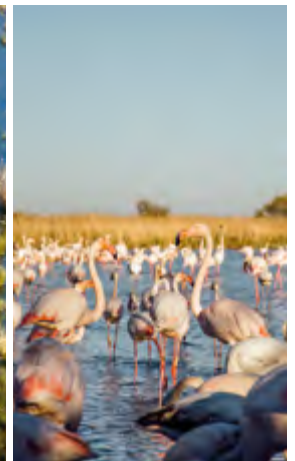

→ Nature reserve: Scamandre discovery centre

Map Legend:

- Nicols base
- Navigation limit
- See p. 10
- No locks in Camargue

BELLEGARDE

Nîmes (17 km), Montpellier (66 km), Marseille (106 km), Lyon (265 km).

A9, A54 2 Garons (12 km).

TGV Nîmes (22 km).

Nîmes (14 km), Montpellier (65 km).

Available fleet page 45 - Boat descriptions pages 46 to 58

DURATION	OUR CRUISE SUGGESTIONS	KM	LOCKS	HOURS
2 DAYS WEEKEND	A Bellegarde > Aigues-Mortes > Bellegarde	72	-	12h
SHORT BREAK	A Bellegarde > Palavas-les-Flots > Bellegarde	122	-	15h30h
1 WEEK	A Bellegarde > Etang de Thau > Bellegarde	196	-	28h
1 WEEK (One way)	A Bellegarde > Etang de Thau > Le Somail	174	14	31h
10 / 11 DAYS	A Bellegarde > Béziers > Bellegarde	270	14	38h

Cruise suggestions: non contractual information, subject to change.



BRIARE - Canal bridge

LOIRE VALLEY / NIVERNAIS

 Canal de Briare - Canal latéral à La Loire - Canal du Nivernais - L'Yonne

This is an easy to access cruising region as close to Paris (2h30).
Explore numerous historical sites and enjoy internationally renowned Sancerre wines and excellent local gastronomy.
There are a wide range of cruise itineraries on both canals and the river Yonne.

FROM PLAGNY

The Canal de Briare runs parallel to the Loire River and the superb Canal du Nivernais and offers peaceful waters alongside the rhythm of enchanting French village life. Set in surroundings between hills and forests the area is dotted with remarkable sites such as: Rogny with its seven locks built during the realm of Henry IV ; **the Briare canal bridge designed by Eiffel** ; **Sancerre and pouilly, renowned for their world famous vineyards** ; la Charité sur Loire (city of books) which is classified by UNESCO as a World Heritage Site and

an essential stop on the route to 'Saint-Jacques-de-Compostella' Apremont-sur-Allier ranked among the most beautiful villages in France and **Nevers, a town full of art, history** and famous for its cathedral and gothic dukes' palace, its Roman church from the 11th century and some of the oldest potteries in France. Lastly nature lovers should visit Bec d'Allier – the meeting point between Loire and Allier, one of the last wild rivers in Europe and classified a 'Panda Site' by the WWF.



LA CHARITÉ-SUR-LOIRE



BECD'ALLIER 

DON'T MISS

	<p>BRIARE: museum of mosaics and metals</p> <p>NEVERS: museum of ceramics - with workshops and activities</p> <p>LA CHARITÉ-SUR-LOIRE: a 'City of Books' and with craftsmen, calligraphers and illuminations</p> <p>GUÉDELON: find many different types of art in the heart of the medieval castle</p>
	<p>WINE APPELLATIONS: Sancerre, Pouilly fumé, coteaux du Giennois</p> <p>POUILLY-SUR-LOIRE: wine-tourism centre</p> <p>SANCERRE: Wine house with tasting sessions and shop</p>
	<p>BEACHES: in Châtillon-sur-Loire, Nevers beach in the summer and at the Guétin canal bridge</p> <p>SWIMMING POOLS: in St-Satur and in Nevers enjoy the pool on the banks of the Loire and watersports centre "Ilot Corail"</p>

→
GUÉDELON
Medieval castle



→
Cycle through the Sancerre vineyards



PLAGNY

Nevers (5 km), Bourges (90 km), Paris (250 km), Lyon (260 km).

A6, A77, Paris (250 km - 2h30).

Nevers (5 km).

Paris-Orly (230 km).

Available fleet page 45 - Boat descriptions pages 46 to 58

DURATION	OUR CRUISE SUGGESTIONS	KM	LOCKS	HOURS
2 DAY WEEKEND	A Plagny > Marseilles-les-Aubigny > Plagny	46	4	8h
	B Plagny > Decize > Plagny	66	10	14h
SHORT BREAK	A Plagny > Sancerre > Plagny	112	22	25h
	B Plagny > Cercy-la-Tour > Plagny	102	22	25h
1 WEEK	A Plagny > Châtillon-s.-Loire > Plagny	180	32	42h
10 / 11 DAYS	A Plagny > Châtillon-en-Bazois > Plagny	176	54	48h
3 WEEKS (whole central loop)	A Plagny > Rogny / Auxerre > Plagny	436	174	98h



NEVERS

Cruise suggestions: non contractual information, subject to change.



BURGUNDY

 Canal de Bourgogne - Canal du Nivernais - L'Yonne

Close to Paris (or 2 hours by car), discover the Canal de Bourgogne - one of the best known canals in France - which winds its way through beautiful Burgundy countryside. Do not forget to discover the richness of its cultural heritage, its world famous wines and cuisine to try!

FROM BRIENON

Brienon is located at the crossroads of **three exceptional waterways**: the Canal de Bourgogne, the Yonne and the Canal du Nivernais.

Cliffs, groves, and waterside vineyards make up the landscape that surrounds the meandering rivers. Numerous castles, **medieval villages** and historic towns invite you to stop: Joigny, Sens, Auxerre (a city full of art and history) or Mailly-le-Château set on a rocky outcrop ...

The area is excellent for **fishing** with many species of fish populating the rivers including pike, carp, perch, bream and many more. Climbers can test their skills and **practice climbing** on the famous rocks at Saussois while wine lovers can visit cellars and **prestigious vineyards** (Châblis, Irancy, Crémant de Bourgogne...)



FROM VENAREY-LES-LAUMES

Cruising the Bourgogne canal is in itself a trip into the history of France whilst at the same time navigating one of the best known canals in the country. An exceptional number of sites and monuments border the canal. The most prestigious is incontestably the Cistercian Abbey of Fontenay (World Heritage of Unesco) but you will also discover a few paces away, or a short bicycle ride, imposing Burgundy castles such as Bussy, Tanlay, Ancy le Franc, Nuits, Maulne...

Prestigious world-renowned wines and excellent traditional Burgundy gastronomy await you at each bend of the canal. Our Venarey base also provides cruising itineraries to discover the Nivernais canal, and stop offs such as Auxerre with its gothic cathedral.





	VENAREY: Alésia Museopark MONTBARD: Fontenay Abbey (UNESCO site) BUFFON: large forges monument in Buffon ANCY LE FRANC ET TANLAY: renaissance castles TONNERRE: Hôtel Dieu and Fosse Dionne AUXERRE: clock tower, Saint-Germain Abbey and Saint-Etienne cathedral
	WINE APPELLATIONS: Chablis, Auxerrois, Tonnerrois, Crémant de Bourgogne FLAVIGNY-SUR-OZERAIN: domaine Flavigny-Alésia TONNERRE: wine cellar visit, tastings and excursions organised by winegrowers CHABLIS: Bèru wine estate SAINT-BRIS-LE-VINEUX: Bailly-Lapierre wine cellars
	GOLF : At Tanlay Castle (9-hole course) and at Venarey (7-hole course)



→ Castle of TANLAY

 Nicols base

 See p. 10

 Briennon: locks closed on 1st May and 14th July

 Venarey: locks closed on 1st May



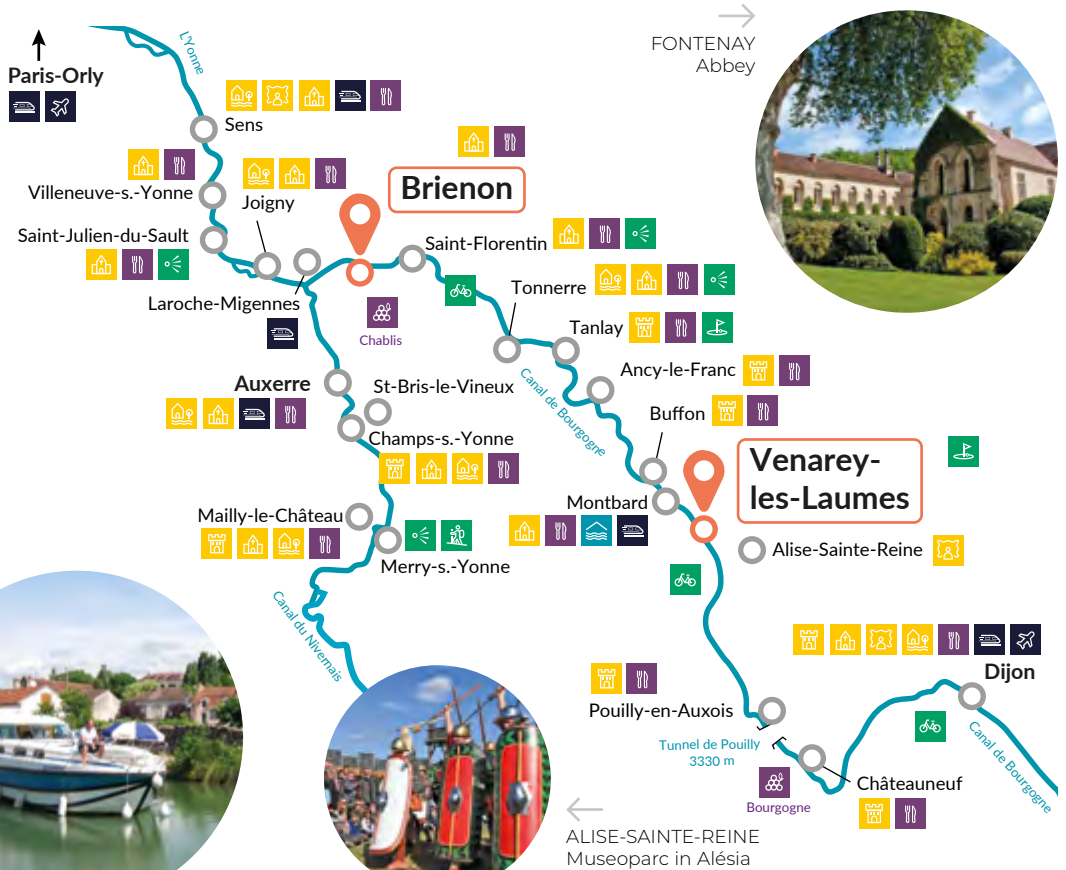

↑ Delicious local foods





 **BRIENON**

Auxerre (30 km), Paris (170 km). A6, Paris-Lyon  18 Joigny (34 km).

 Laroche-Migennes (10 km).

 Laroche-Migennes (Paris - 1h20).

 Paris-Orly (150 km).

 **VENAREY-LES-LAUMES**

Montbard (15 km), Dijon (70 km).

A6 (Paris - 365 km - 2h45),  23 Bierre-les-Semur (25 km).

 TGV Montbard (14 km), Les Laumes-Alésia (2 km).

 Paris-Orly (255 km), Lyon (270 km), Dijon (73 km).

 Available fleet page 45 - Boat descriptions pages 46 to 58

DURATION	OUR CRUISE SUGGESTIONS	KM	LOCKS	HOURS
2 DAY WEEKEND	A Briennon > Joigny > Briennon	36	10	9h
	B Briennon > Saint-Florentin > Briennon	20	8	6h
SHORT BREAK	A Briennon > Villeneuve-s.-Yonne > Briennon	74	16	17h
	B Briennon > Tonnerre > Briennon	70	32	20h
	C Briennon > Auxerre > Briennon	64	22	16h
1 WEEK	A Briennon > Sens > Briennon	106	22	23h
	B Briennon > Ancy-Le-Franc > Briennon	130	62	38h
	C Briennon > Mailly-le-Château > Briennon	154	68	43h
1 WEEK (One way)	A Briennon > Saint-Florentin > Tonnerre > Montbard > Venarey	108	57	32h
	A Briennon > Clamecy > Briennon	200	90	54h
3 WEEKS (The whole central loop)	A Briennon > Plagny > Rogny > Briennon	436	174	98h

 Available fleet page 45 - Boat descriptions pages 46 to 58

DURATION	OUR CRUISE SUGGESTIONS	KM	LOCKS	HOURS
2 DAY WEEKEND	A Venarey > Buffon > Venarey	40	26	10h
SHORT BREAK	A Venarey > Ancy-le-Franc > Venarey	82	50	21h
1 WEEK	A Venarey > Tanlay > Venarey	124	68	31h
1 WEEK (One way)	A Venarey > Montbard > Tonnerre > Saint-Florentin > Briennon	108	57	32h
10/11 DAYS	A Venarey > Tonnerre > Venarey	144	80	38h
	B Venarey > Pouilly-en-Auxois > Venarey	80	108	54h
2 WEEKS	A Venarey > Châteauneuf > Venarey	98	130	90h



DOLE

FRANCHE-COMTÉ / SAÔNE

 La Saône - Canal du Rhône au Rhin - Canal de Bourgogne - Canal des Vosges

A crossroads of rivers that offer an excellent choice of cruises: the deep valley of the Doubs, the naturally charming Saône, with few locks, a fishing paradise!
For the gourmets, cheese and fine Franche-Comté wines.

FROM PORT-SUR-SAÔNE

From here, you will navigate along **peaceful waterways**, dotted with **typical small villages** revealing the history of the river: Port-sur-Saône, Gallo-Roman village in the origin, Gray fascinating with its patrimonial treasures, unless you have chosen to sail on the Vosges canal to discover the densely wooded countryside of the Vosges: here you will be charmed with the calm of unspoiled nature - so don't forget your binoculars!



PORT-SUR-SAÔNE

FROM DOLE

Dole, ancient capital of la Comté, doorway to the Jura and birth-place of Pasteur, situated in the heart of a marvellous region gifted with **one of the most beautiful navigation areas** offering a very large choice of cruising: le canal du Rhône to the Rhin (in fact it's the Doubs) with Besançon and citadel of Vauban, Baume les Dames, the charm of Comtois villages and market towns, wild beauty of fauna and flora in the superb deeply embanked valleys. You can cruise upstream one way to Port sur Saône or the Burgundy canals beyond Saint-Jean-de-Losne.

Warning: we recommend that you've had some previous boating experience if cruising on the river Doubs.



DON'T MISS

	BESANÇON: Vauban citadel AUXONNE: Castle of King Louis XI DOLE: birthplace of Pastor and church of Notre Dame GRAY: Notre Dame Basilica (19 th century) RAY-SUR-SAÔNE: castle (18 th century)
	DOLE: waterpark and tree-top course GRAY: waterpark with swimming pool and slides OSSELLE-PLAGE: sandy beach, swimming pool with slide OSSELLE: prehistoric caves BESANÇON: zoo and Okidok (indoor leisure park) MONTBÉLIARD: Près la Rose science park
	Pikes, carp, catfish, bream Fishing in the river (Doubs, Saône) and in ponds (Osselle)
	GOLF COURSES: 18-hole courses in Parcey (10 minutes from Dole), Besançon and Epinal



→ RAY-SUR-SAÔNE



→ DOLE
Aquaparc Isis

Local
gastronomy

- Nicols base
- See p. 10
- Locks closed on 1st May

PORT-SUR-SAÔNE

- Vesoul (15 km), Besançon (63 km),
- Dole (108 km), Dijon (150 km). A5 > A31 7 Langres.
- Paris (350 km, 3h45). Vesoul (15 km).
- Dijon (150 km), Bâle (150 km).

DOLE

- Besançon (55 km), Dijon (50 km).
- A36, Paris (370 km, 3h30).
- TGV Dole (1 km).
- Lyon (200 km).

Available fleet page 45 - Boat descriptions pages 46 to 58

DURATION	OUR CRUISE SUGGESTIONS	KM	LOCKS	HOURS
2 DAY WEEKEND	A Port-s.-Saône > Ray-s.-Saône > Port-s.-Saône	80	14	13h
	B Port-s.-Saône > Selles > Port-s.-Saône	82	16	15h
SHORT BREAK	A Port-s.-Saône > Gray > Port-s.-Saône	124	22	24h
1 WEEK	A Port-s.-Saône > Mantoche > Port-s.-Saône	158	22	26h
	B Port-s.-Saône > Bains-Les-Bains > Port-s.-Saône	118	44	28h
1 WEEK (One way)	A Port-s.-Saône > Gray > Dole	154	23	24h
10/11 DAYS	A Port-s.-Saône > Epinal > Port-s.-Saône	210	132	65h

Available fleet page 45 - Boat descriptions pages 46 to 58

DURATION	OUR CRUISE SUGGESTIONS	KM	LOCKS	HOURS
2 DAY WEEKEND	A Dole > Osselle > Dole	72	20	13h
	B Dole > Auxonne > Dole	64	20	12h
SHORT BREAK	A Dole > Besançon > Dole	112	40	23h
	B Dole > Mantoche > Dole	150	24	22h
	C Dole > Verdun-sur-le-Doubs > Dole	114	18	19h30
1 WEEK	A Dole > Baume-les-Dames > Dole	182	62	37h
	B Dole > Ray-sur-Saône > Dole	250	32	40h
1 WEEK (One way)	A Dole > Gray > Port-sur-Saône	154	23	24h
10/11 DAYS	A Dole > Ray-sur-Saône > Dole	223	34	45h
	A Dole > Montbéliard > Dole	294	114	68h30
2 WEEKS	B Dole > Selles > Dole	434	60	76h



ARZVILLER - Inclined plane

ALSACE

 Canal de la Marne au Rhin - Canal de la Sarre - La Moselle

Enjoy a French boating holiday in the Alsace, a region full of history and fantastic gastronomy. The best bits : magnificent scenery - mountains and forests frame your route ; delicious regional food and wines ; watersports, cycling and hiking - something for everyone! Wonderful art and architecture in the cities...

FROM SAVERNE AND HASKIRCHEN

Start your boating holiday from Saverne in Alsace, a land of history and gastronomy. Choose to either cruise towards Strasbourg or towards Arzviller - **famous for its boat lift (the only one in France)**.

Beyond that, you get to the green Lorraine plateau and continue your cruise to **Nancy**, stopping on route at the superb Place Stanislas, **listed as a UNESCO World Heritage Site**.

At Gondrexange you take the Canal de la Sarre which is dotted with **lakes and water spots offering beaches, swimming, and watersports**.

From Harskirchen, location of our second base in Alsace (see our one way cruise option between Saverne and Harskirchen) you can cruise to Sarreguemines which is **famous for its pottery** or Saarbrücken which takes you just over the German border.

European Cruise: Enjoy a cruise through three countries! Take your boat through France, Germany and Luxembourg. Choose a three week itinerary from Saverne or two weeks if starting from Harskirchen.



EXCLUSIVE: the Sixto® and the Quattro® Green are the first electric powered boats (see details on page 48 and 51).



LUTZELBOURG valley

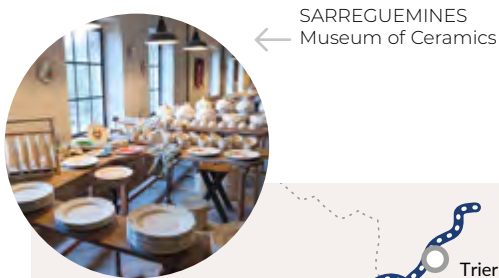

SARREGUEMINES
Museum of Ceramics



DOMAINE SAINTE-CROIX
Animal park



SAVERNE



STRASBOURG
'La Petite France'

DON'T MISS

	LÜTZELBOURG: crystal works INCLINED PLANE: glass blower workshops and crystal works SARREGUEMINES: ceramics production
	SAVERNE: castle of Rohan, castle of Haut-Barr ARZVILLER: the inclined plane, unique in France SARREBOURG: stained glass chapel window by Chagall NANCY: Place Stanislas square, Palace of the Dukes
	Zoo and fauna park at Sainte-Croix and "Nature de Cheval" equestrian centre in Altwiler, alpine luge rides at the Arzviller incline Waterparks in Saverne (Océanide) and Hochfelden (Atoo), beach and water based activities in Mittersheim
	GOLFS: 18-hole courses in Nancy and Sarreguemines, 27-hole course in Strasbourg

SAVERNE

Strasbourg (41 km).

- A4, 45, Paris (450 km - 4h15).
- TGV Paris-Strasbourg, TGV Saverne (600 m).
- Strasbourg (40 km).

HARSKIRCHEN

Sarreguemines (25 km), Saarbrücken (40 km).

- A4, 43 Sarre-Union.
- TGV Sarre-Union, (4 km).
- Strasbourg (80 km), Metz-Nancy (80 km).

Available fleet page 45 - Boat descriptions pages 46 to 58

DURATION	OUR CRUISE SUGGESTIONS	KM	LOCKS	HOURS
2 DAY WEEKEND	A Saverne > Niderviller > Saverne	44	24	12h
SHORT BREAK	A Saverne > Strasbourg > Saverne	92	40	22h
	B Saverne > Réchicourt > Saverne	92	28	20h
(One way)	C Saverne > Harskirchen	73	30	18h
1 WEEK	A Saverne > Mittersheim > Saverne	122	50	32h
	B Saverne > Boofzheim > Saverne	142	60	36h
10/11 DAYS	A Saverne > Nancy > Saverne	208	66	46h30
	A Saverne > Sarreguemines > Saverne	208	78	54h
2 WEEKS	B Saverne > Nancy > Toul > Saverne	281	103	69h30
	A The «European cruise»	469	97	102h30

Available fleet page 45 - Boat descriptions pages 46 to 58

DURATION	OUR CRUISE SUGGESTIONS	KM	LOCKS	HOURS
2 DAY WEEKEND	A Harskirchen > Sarreguemines > Harskirchen	64	20	14h30
	B Harskirchen > Pont d'Albeschaux > Harskirchen	46	32	15h
SHORT BREAK (One way)	A Harskirchen > Saverne	73	30	18h
SHORT BREAK	A Harskirchen > Réchicourt > Harskirchen	86	38	23h
	B Harskirchen > Saarbrücken > Harskirchen	108	32	24h
	A Harskirchen > Lützelbourg > Harskirchen	124	44	30h
1 WEEK	B Harskirchen > Arzviller > Réchicourt > Harskirchen	126	38	29h
	A Harskirchen > Nancy > Harskirchen	202	82	50h
10/11 DAYS	A Harskirchen > Nancy > Toul > Harskirchen	264	115	70h
	B Harskirchen > Strasbourg > Harskirchen	238	92	58h



SCHWERIN

MECKLENBURG-WEST

Explore green countryside and beautiful waterways!

A quiet region with numerous cruises across lakes surrounded by rich flora and fauna.

FROM LÜBZ

Lübz is a small town with its town centre dating back to the middle age. It's also a great starting point for navigating the area from Mecklenburg to Brandenburg through 15,000 hectares of forests and across 33 lakes covering over 54 km².

The district of Lübz enjoys the most beautiful countryside in this region of Germany.

The river Elde is navigable for 180 km and has only 17 locks. In only five hours it is possible to reach Lake Plauer - one of the largest lakes in the region. On the northern banks there is a nature reserve of 300 hectares and a paradise for those who love nature and bird life.



WAREN





RÖBEL

EVEN MORE COMFORT ONBOARD!



The whole fleet of Lübz benefit from special equipment such as: stem propeller, quay plug 220 volts, radio / CD / MP3, bathing ladders.

DON'T MISS

	PLAU: castle with tower SCHWERIN: castle with gardens, 18 th century market square, half-timbered and gabled houses from the end of the 17 th century MALCHOW: town mill
	MÜRITZ NATIONAL PARK: 322 km ² of forests, lakes and marshes and the largest lake in Germany with more than 150 species of birds. WAREN: Müritzeum aquarium BÄRENWALD MÜRITZ: a bear protection scheme in the forest
	Swimming in the clear waters of the lake!



FOR NON-LICENCE HOLDERS
Extra 3 hours of instruction required at a cost of 50€ to be paid locally.

-  Nicols base
-  See p. 10
-  Locks are open all season







→ MÜRITZ national park



→ MIROW



LÜBZ

-  Schwerin (70 km).
-  A24 Berlin (175 km),  16 > Parchim, A24 Hamburg (151 km)
-  14 > Parchim.
-  Parchim (15 km).
-  Hamburg (180 km), Berlin (220 km).

 Available fleet page 45 - Boat descriptions pages 46 to 58

DURATION	OUR CRUISE SUGGESTIONS	KM	LOCKS	HOURS
1 WEEK	A Lübz > Röbel > Lübz	84	8	17h30
	B Lübz > Schwerin > Lübz	149	8	26h30
	C Lübz > Dömitz > Lübz	97	13	19h30

Cruise suggestions: non contractual information, subject to change.



GERMANY

RHEINSBERG castle

MECKLENBURG-EAST

Between Mecklenburg and Brandenburg, in the heart of a thousand lakes, discover nature at its finest in an area known as "Blue Paradise".

FROM FÜRSTENBERG



The Nicols base in Fürstenberg is located at the crossroads of two regions: north-west is Mecklenburg with its 1000 lakes while in the south-east is Brandenburg towards Berlin. Choose from a number of different cruising itineraries ranging from a couple of days in length up to two week holidays.

A natural paradise: the landscapes and greenery between the lakes, rivers and canals are stunning and you'll discover an abundance of flora and fauna. Bird-watchers should head to Lake Müritz and look out for eagles, cormorants, cranes and osprey.

Take a dip: if you like swimming then the clear waters of the lakes in this fascinating region is ideal. The water quality is up there with the best in Europe – at certain times of the year the water is clear enough for vision down to 12 metres deep – so perfect for underwater photos and spotting fish!

Rich historical heritage: your boating holiday leads you to some fine treasures of the past! Towards Mecklenburg (north-west) you will find Rheinsberg and its castle, the curious lakeside houses with thatched roofs of Mirow, Röbel and its half-timbered houses, Waren and the "Müritzeum" - a visitor centre for the Müritz National Park. Alternatively if you head towards Brandenburg (south-east) you'll reach Himmelfort which is known as the capital of fishing (try the local specialty of smoked fish) and hometown of Santa Claus, before then reaching the charming little walled town of Templin.

For those customers who have a boat licence, Berlin and Potsdam are also great places to visit. Contact us for more information.



Lake MÜRITZ

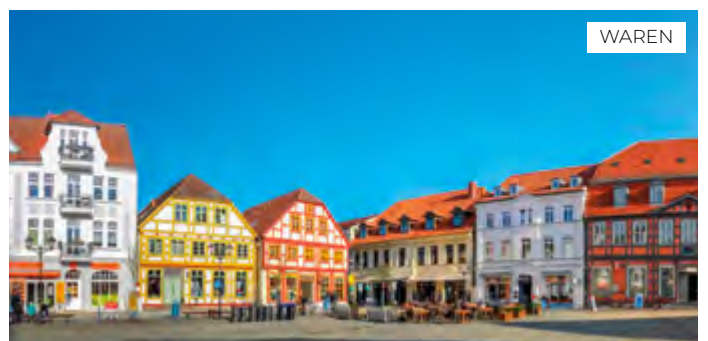



WAREN

DON'T MISS

	NEUSTRELITZ: baroque style castle RHEINSBERG: castle "Rococo" where a famous festival of classical music and opera takes place each summer
	MÜRITZ NATIONAL PARK: 322 km ² of forests, lakes and marshes and the largest lake in Germany with more than 150 species of birds. WAREN: Müritzeum aquarium BÄRENWALD MÜRITZ: a bear protection scheme in the forest
	Swimming in some of the clearest and best quality waters and lakes in Europe.

 **FOR NON-LICENCE HOLDERS**
Extra 3 hours of instruction required at a cost of 50€ to be paid locally.

FÜRSTENBERG

- Berlin (70 km).
- A10 Berlin (80 km),  31 - Oranienburg - B96 (45 km).
-  Fürstenberg (Berlin - 1h).
-  Berlin Tegel (90 km), Berlin Schönefeld (120 km).

 Available fleet page 45 - Boat descriptions pages 46 to 58





DURATION	OUR CRUISE SUGGESTIONS	KM	LOCKS	HOURS
2 DAY WEEKEND	A Fürstenberg > Priepert > Neustrelitz > Fürstenberg	60	6	12h
	B Fürstenberg > Templin > Fürstenberg	80	14	17h
SHORT BREAK	A Fürstenberg > Neustrelitz > Wesenberg > Rheinsberg > Fürstenberg	100	12	20h
	B Fürstenberg > Neustrelitz > Rheinsberg > Mirow > Fürstenberg	193	20	24h
1 WEEK	A Fürstenberg > Mirow > Waren > Röbel > Rheinsberg > Fürstenberg	225	10	30h
	B Fürstenberg > Himmelfort > Lychen > Templin > Zehdenick > Fürstenberg	204	20	22h
	C Fürstenberg > Mirow > Waren > Malchow > Plau > Lübz > Waren > Schwerin > Fürstenberg	300	14	40h
10/11 DAYS	A Fürstenberg > Neustrelitz > Rheinsberg > Waren > Plau > Schwerin > Fürstenberg	460	32	54h
	B Fürstenberg > Strasen > Neustrelitz > Buchholz > Rheinsberg > Lychen > Templin > Zehdenick > Fürstenberg	310	32	55h

NB : From Zehdenick, navigation require a boat licence



Regional speciality: smoked fish



-  Nicols base
-  Navigation limit
-  Licence necessary
-  See p. 10
-  Locks are open all season

Cruise suggestions: non contractual information, subject to change.



NETHERLANDS

HOLLAND

Maas - Merwedekanaal - Vecht - Gouwe

Famous for windmills, cheese, tulips and of course canals, the Netherlands is the perfect destination for enjoying a boating holiday! Captain a Nicols boat and discover picturesque towns and villages, art and history museums and the stunning Natura 2000 listed national park. Natural waters are great for swimming and of course bikes on board mean that you can enjoy the national pastime of cycling!

FROM KERKDRIEL

Kerkdriel is a great location to have a Nicols base as in addition to the waters being calm and ideal for beginners to boating, they are also perfect for swimming and fishing.

Surrounding the waterways is beautiful flora and fauna including the “De Biesbosch” national park which is one of the largest found in the Netherlands. It is recognised as a wetland of international importance and is listed as a Natura 2000 area by the EU Habitat and Birds Directives.

The town of Gouda is famous for its tasty cheese but even if you don't like cheese we recommend a visit to explore the charming old town with the Sint-Jans church (famous for the impressive stained glass windows), markets and bustling streets.

Amsterdam is the largest city in the Netherlands and is dissected by a network of canals. Visit museums of art (including Van Gogh), history and science and take time to simply wander through the colourful streets for shopping, restaurants, cafes and of course the famous Red Light District.

One of the many cruising routes on offer from Kerkdriel will lead you and your crew to Maastricht – the city known to be the origin of the European Union. Explore the many cultural and historic buildings including the ramparts and tower before enjoying a shopping spree along the streets that are lined with trendy designer shops.



AMSTERDAM



DON'T MISS

	Biesboch National Park, a Natura 2000 listed area Numerous nature reserves: Maasbommel, Mook-Plamsolen, Tiengemeten, Leukermeer
	GOUDA: Sint-Jans church, charming city streets AMSTERDAM: art museums (Van Gogh Museum), history and science museums, Red Light District, house of Anne Frank WOUDRICHEM: medieval castle of Loevestein (14 th century) HEUSDEN: fortified city.
	SPECIALITIES: Gouda cheese from Gouda! The 'Bossche bowl': a profiterole type pastry from the Dutch city of 's-Hertogenbosch 'Stroopwafels': caramel filled waffles The 'broodje haring': raw herring sandwiches served with onions 'Stamppot': traditional dish made with mashed potato, sauerkraut, carrots or onions 'Bitterballen': a soup with peas, rye bread and bacon - Many Dutch beers!
	The popularity of bikes here means there are many cycle routes to be enjoyed.

KERKDRIEL

Amsterdam (90 km), Bruxelles (160 km), Düsseldorf (165 km)
Paris (450 km), Hamburg (465 km).

- A2 19 Kerkdriel.
- Bois-le-Duc (14 km), Utrecht (50 km).
- Amsterdam Schiphol (90 km).

Available fleet page 45 - Boat descriptions pages 46 to 58

DURATION	OUR CRUISE SUGGESTIONS	KM	LOCKS	HOURS
2 DAY WEEKEND	Kerkdriel > Heusden > Gorinchem > Kerkdriel	100	2	12h
SHORT BREAK	Kerkdriel > Biesboch > Kerkdriel	120	0	15h
1 WEEK	Kerkdriel > Rotterdam > Gouda > Gorinchem > Heusden > Kerkdriel	200	9	25h
1 WEEK (One way)	Kerkdriel > Gouda > Amsterdam > Utrecht > IJsselstein > Montfoort	220	8	28h
10/11 DAYS	Kerkdriel > Woudrichem > IJsselstein > Gouda > Uithoorn > Amsterdam > Weesp > Utrecht > Gorinchem > Heusden > Kerkdriel	202	12	36h30
2 WEEKS	Kerkdriel > Bois-le-Duc > Veghel > Maastricht > Venlo > Ravenstein > Kerkdriel	350	22	60h

1 hour of navigation instruction required at a cost of 50 € and to be paid at the time.

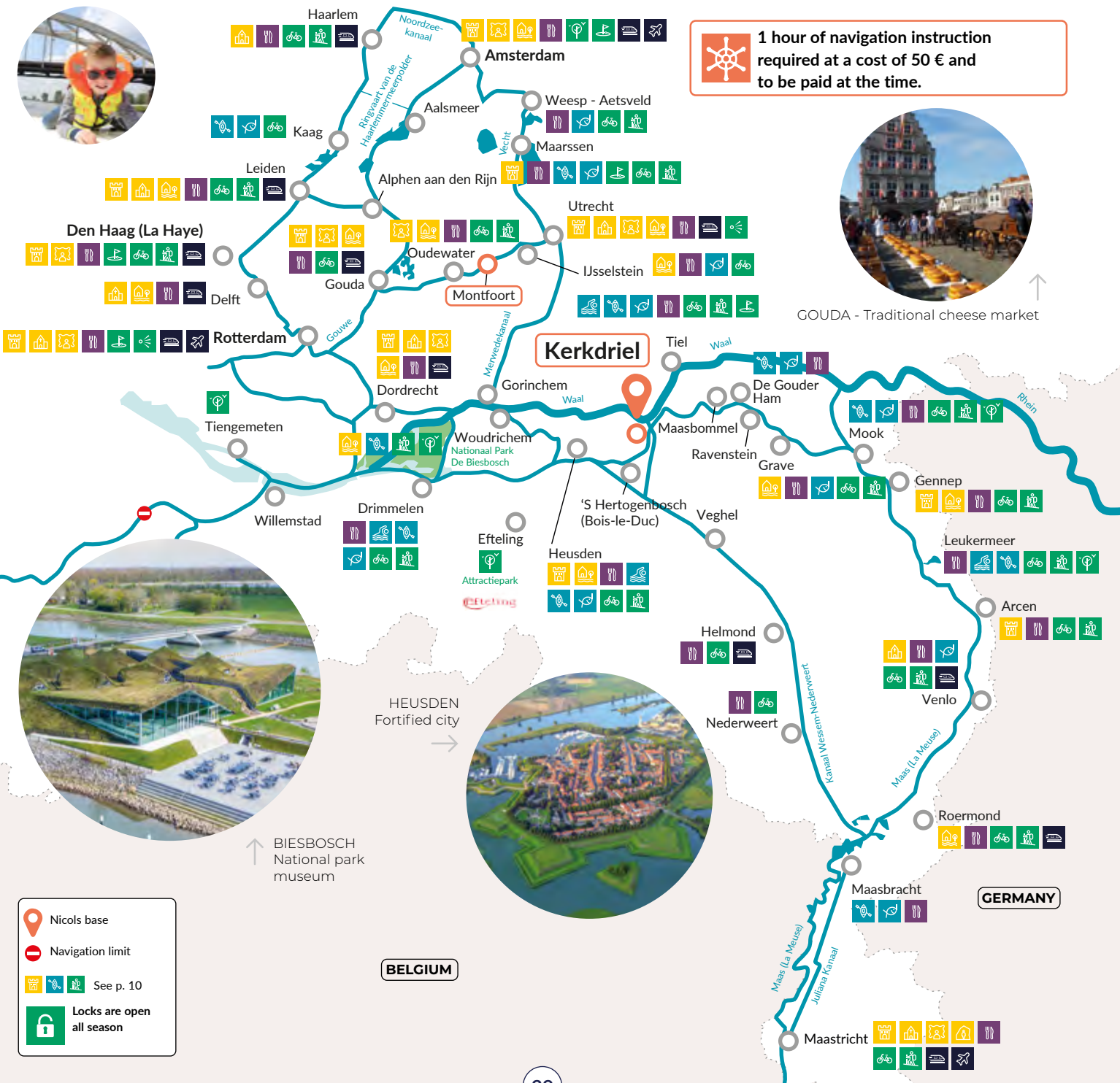

- Nicols base
- Navigation limit
- See p. 10
- Locks are open all season

BELGIUM

GERMANY

Cruise suggestions: non contractual information, subject to change.



HUNGARY

TISZA

TOKAJ AND LAKE TISZA



Set sail on the rural rivers of Hungary! Nicols have two departure bases to choose from - Kisköre in the south sailing between lakes and national parks or Tokaj in the north and in the heart of a world-famous wine region.

FROM TOKAJ

Tokaj is located on the banks of the Bodrog River and is known as a city of wines and festivals. There are many excellent restaurants and wineries which have been listed on the UNESCO World Heritage List including **the famous Tokaj wine** that Louis XIV described as "the wine of kings and the king of wines"!

You can cruise in three directions from the Nicols Tokaj base. Heading along the Bodrog River you can reach the town of Sátoraljaújhely on the border of Slovakia. While here visit **the large Zemplén Adventure Park**. On the return journey, spend a night moored close to **the castle of Sárospatak** and stop off at the village of Bodrogkeresztúr where you can go canoeing in the protected Bodrogzug-Tokaj Park. Throughout your journey you'll be surrounded by mountains and vineyards.

The other available itineraries from Tokaj are a cruise on the Upper Tisza to the north towards Tiszabercel and then to Dombbrád, or in the other direction south through pretty countryside and cruising until the hydroelectric power station of Tiszalök before returning to Tokaj.



TOKAJ - vineyard

FROM KISKÖRE

A cruise from Kisköre sees you switch between navigating on lakes and rivers – with stop offs at Abádszalók and Tiszafüred for **swimming, fishing** or dinner in the evening in a local restaurant to discover Hungarian cuisine. Sailing upstream on the Tisza River takes you to Tiszacsege, where **the famous fish restaurant "Halászcserda"** awaits you. Continue your cruise to Tiszalök, where you'll find the impressive hydroelectric power station which can be visited. On the return journey, stop at Andrassy Castle in Tiszadob, then on to Lake Tisza and then to Poroszló and **the 'Ecocentre' with its giant aquarium** – the perfect family visitor attraction. Nature lovers should also explore **the Hortobágy National Park** where you'll also find **the famous Hungarian "Puszta"** (the largest grassland plain in Central Europe), a UNESCO World Heritage Site.



TISZADOB - Andrassy Castle



DON'T MISS



Historical vineyard of the Tokaj-Hegyalja region (World Heritage Site since 2002), Bodrogkeresztúr, Sárospatak, Herceghút and Sátoraljaújhely vineyards



Swimming possibilities in Kisköre, Abádszalók, Tiszafüred, Sarud and Poroszló. Swimming in safe and clean rivers.



Hortobágy National Park - La Puszta grassland (UNESCO World Heritage Site), Bodrogzug-Tokaj Protected Park, Ecocentre and the giant aquarium at Poroszló



TOKAJ: its UNESCO heritage listed wineries, **SÁROSPATAK:** castle (15th - 16th century), **TISZADOB:** Andrassy castle, **SZABOLCS:** church (11th century)



→ TISZA

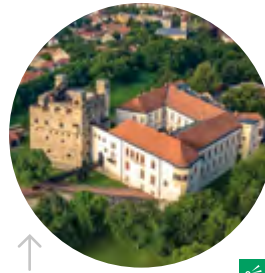

SÁROSPATAK Castle

Miskolc



Tiszaújváros



Tiszacsege



Debrecen

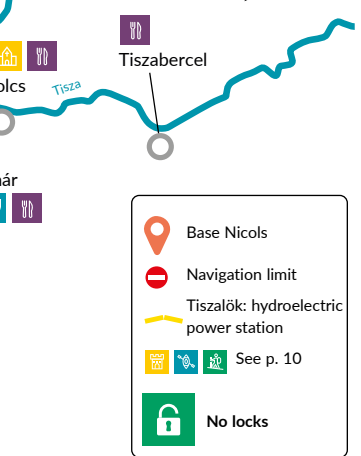

- Base Nicols
- Navigation limit
- Tiszalök: hydroelectric power station
- See p. 10
- No locks

Tasting of Tokaj wines →



→ ZEMPLEN - Adventure park

→ SARUD



→ Bird lovers paradise



TOKAJ

Miskolc (55 km), Nyíregyháza (32 km).

M3, 37, Budapest (230 km, 2h30).

Miskolc (55 km).

Budapest (230 km), Debrecen (90 km), Košice (SK) (85 km).

KISKÖRE

Eger (56 km), Debrecen (108 km).

M3, 31, Budapest (145 km, 1h30).

Füzesabony (35km).

Budapest (150 km), Debrecen (150 km).

Available fleet page 45 - Boat descriptions pages 46 to 58

DURATION	OUR CRUISE SUGGESTIONS	KM	LOCKS	HOURS
2 DAY WEEKEND	Tokaj > Sárospatak > Tokaj	74	0	9h
SHORT BREAK	Tokaj > Sátoraljaújhely > Dombrád > Tokaj	200	0	25h
1 WEEK	Tokaj > Sátoraljaújhely > Dombrád > Tokaj	250	0	31h
1 WEEK (One way)	Tokaj > Kisköre	256	1	26h30
10/11 DAYS	Tokaj > Tiszabercel > Dombrád > Tímár > Tokaj Sárospatak > Sátoraljaújhely > Bodrogkisfalud > Tokaj > Tiszalök > Tokaj	247	0	30h

Available fleet page 45 - Boat descriptions pages 46 to 58

DURATION	OUR CRUISE SUGGESTIONS	KM	LOCKS	HOURS
2 DAY WEEKEND	Kisköre > Tiszafüred > Kisköre	60	0	8h
SHORT BREAK	Kisköre > Tiszacsege > Kisköre	100	0	12h
1 WEEK	Kisköre > Tisza lake > Tiszalök > Kisköre	230	0	29h
1 WEEK (One way)	Kisköre > Tokaj	256	1	31h00
10/11 DAYS	Kisköre > Tiszalök > Abádszalók > Kisköre	232	0	28h30



MONSARAZ

LAGO ALQUEVA



Enjoy plenty of sunshine and swimming and watersports in clean warm waters. Anglers can fish for black bass, carp and more. Numerous activities await such as cycling, quad bike riding or for a slower pace of life why not discover the richness of fauna and flora, or historical interests such as fortified villages, archaeological sites and locally produced traditional handicrafts and pottery. Taste regional traditional cooking and a meal with a view at the panoramic restaurant on the port. Don't forget our Amieira team offer an 'onboard menu' and 'onboard shopping' service.

FROM AMIEIRA MARINA



The region boasts waters of an incredible quality, where both nature lovers and watersports fans will find an abundance of things to see and do. Remember your camera as there are photo opportunities aplenty!



Head with your crew of family or friends **to moor on an islet for a night 'Robinson Crusoe' style** or venture to other stops that allow easy access to the beautiful surrounding villages and places of interest such as the Alqueva dam, an amazing structure built in 2002. Other places to visit are the new identically built village

of Luz, replacing the old Luz that was swallowed up by the Lago Alqueva (don't miss the museum); **Mourão with its castle and fortifications from the 13th century**; the fortified city of Monsaraz with its narrow and paved streets and a splendid bullring.





With more than 300 sunny days per year a boating holiday on the Lago Alqueva can be enjoyed at any time of the year!



DON'T MISS

	MOURÃO: castle and fortifications (13 th century) MONSARAZ: fortified city LUZ: rebuilt village after flooding and museum
	Swimming and diving in the clean waters of the lake, watersports, shaded and supervised beaches in Amieira, Mourão and Monsaraz.
	Black bass, pikeperch, pike, barbed comizo Lure fishing and rock fishing



 Nicols base
 Dam
 See p. 10
 No locks



AMIEIRA MARINA

Evora (60 km), Lissabon (180 km).
 A6 Lissabon (2h), A2 Faro (2h30), IP2 Evora (45 mn).
 Lissabon, Faro et Badajoz, Sevilla, Madrid (ESP).



**DESTINATION PORTUGAL:
OPEN ALL YEAR ROUND!**

 Available fleet page 45 - Boat descriptions pages 46 to 58

DURATION	OUR CRUISE SUGGESTIONS	KM	LOCKS	HOURS
2 DAY WEEKEND	Amieira > Mourão > Amieira	88,5	-	10h
SHORT BREAK	Amieira > Monsaraz > Amieira	163	-	18h
1 WEEK	Amieira > Juromenha > Amieira	278	-	30h

 For car rental advice from Lisbon or Faro airports please contact us for more details.

TEMPERATURES AT LAKE ALQUEVA

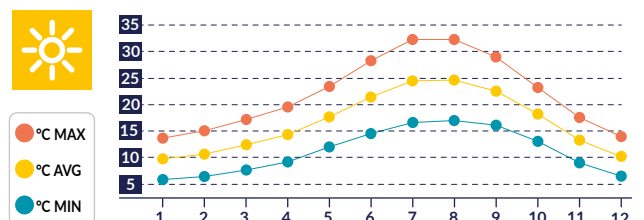

All our boats are equipped with 1 quay plug 220 Volts, electric toilet, sounders, GPS, monitor / DVD, solar panels. For rent at the base: bikes, canoes, kayaks...

THE NICOLS® FLEET



The key to a successful boating holiday is in choosing the best boat from our five different ranges: Fly, Estivale, Confort, Sedan or Riviera. The following information will help you make your selection of boat before reading full details boat by boat over the next pages (pages 44 to 58)



WHAT IT IS THAT MAKES NICOLS BOATS SO GOOD!



Our boats have a vast living room with a **360° panoramic view**. The kitchen includes lots of equipment and has everything you'll need: **220l fridge with a freezer compartment***, ring-hob, oven / grill depending on boat model * and wide work top areas. The kitchenware is supplied as well as the bedding (sheets, duvets, pillows). Terraces are equipped with garden furniture and either a sun awning or parasol depending on the boat model.

**Fridge 220l except on: Riviera range, N800 and Primo®. Oven: except N800.*

To make moving from one end of the boat to the other safe and easy all our walkways are covered with an anti-slip surface, have a hand rail and a double railing* at a height of 60 cm (safety criteria imposed by the legislation for boats made in France). The rear terrace on the Sedan and Estivale ranges are on the same level as the living room meaning there are no stairs to negotiate going either in or out of the boat. The front terrace of the Confort range can be reached via a gangway 1 metre high moulded into the hull deck for the maximum safety. All these criteria mean that **Nicols® boats are one of the safest on the market**, particularly when it comes to **accommodating crews with children and/or people with reduced mobility**.

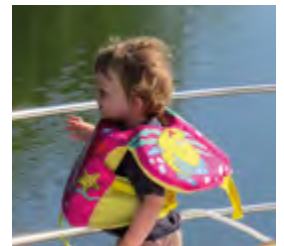

**except N800 and Primo®*

A key to the main equipment found on board a Nicols® boat



Heating



Sun awning sliding / Sun awning



Electric toilets



DVD monitor



Microwave



Air conditioning



Double steering position



Electrical connector 220 V on board



Stem propeller



TV with satellite channels



Dishwasher

MAKE YOUR CHOICE - THERE'S A BOAT FOR YOU!



Read our detailed boat descriptions.

Example: a boat described as being a 4/6 is a boat which offers 4 beds in cabins plus 2 extra bed spaces in the converted saloon area.

REGIONS →		NICOLS® BASES →																								
		BRITTANY		ANJOU		CHARENTE	LOT	AQUITAINE	MIDI	CAMARGUE	VAL DE LOIRE NIVERNAIS	BURGUNDY	FRANCHE-COMTÉ	SAÔNE	ALSACE	GERMANY	NETHERLANDS	HUNGARY	PORTUGAL							
		Glénac	Sucé-sur-Erdre	Sablé-sur-Sarthe	Grez-Neuville	Sireuil	Cahors	Buzet	Le Somail	Port-Lauragais	Bellegarde	Plagny	Briennon	Venarey	Dole	Port-sur-Saône	Harskirchen	Saverne	Lübz	Fürstenberg	Kerkdriel Montfoort	Kisköre	Tokaj	Amieira		
BOAT	CAPACITY																									
NEW	QUATTRO® FLY C	4/6																								
	QUATTRO® FLY C GREEN	4/6																								
	SIXTO® FLY C	6/8																								
	OCTO® FLY	8/10																								
	OCTO® FLY C	8/10																								
ESTIVALE	DUO®	2/4																								
	QUATTRO	4/6																								
	QUATTRO B	4/6																								
	QUATTRO S®	4/6																								
	SIXTO® PRESTIGE C	4/6																								
	SIXTO®	6/8																								
	SIXTO® GREEN	6/8																								
	OCTO®	8/10																								
CONFORT	C900 DP	5/7																								
	C1100	7/9																								
	C1350	8/10																								
	C1350 B	8/10																								
SEDAN	N800	2/3																								
	PRIMO®	2/4																								
	N1000	6/8																								
	N1010	6/8																								
	N1150	8/10																								
	N1160, N1160N	8/10																								
	N1170	8/10																								
	N1310	10/12																								
RIVIERA	R920	6/8																								
POOL*																										

* : If renting the splash pool for a boat of 13m or more a compulsory license is required. Can be added to all boats except the Fly range, N800, Primo® and R920.

FLY RANGE



The Fly range – Nicols® biggest and best boat yet!



OCTO® FLY C



KEY FACTS



- Upper deck with kitchen / breakfast area
- Sun awning and deck mattress
- Covered rear terrace
- Private bathroom for each cabin



ALFRESCO
DINING AREA



CABIN



AWNING & MATTRESS

THE FLY RANGE is the latest series from the nicols boatyard. its models, ranging from 12.95m to 15m long, are some of the easiest boats to steer thanks to their double bow thruster (stern and bow).

We're confident that our boats in the Fly range offer the best accommodation available anywhere in the boating holidays market. They come fully-equipped with: large fridge, hob and oven, television with satellite antenna, radio / CD / MP3, 220 V shore power connection, our 'C' boat models even have an on board generator for using 220 V power during navigation and **air-conditioning**, which provides extra comfort in the summer months!

The boats have a covered rear terrace with outdoor dining furniture and access to the upper deck area which has a breakfast area + outdoor kitchen (sink, plancha grill) under the shade of a bimini awning, a second outdoor steering position and a deck area for two mattresses – the perfect space for lazing in the sun.

So what are you waiting for? Be the envy of the others on the waterways and travel in style and comfort – no previous boating experience or licence is needed.





Upper deck with deck mattress



Upper deck with kitchen / breakfast area



Living area and fully-equipped kitchen



Covered rear terrace

	Quattro® Fly C	Quattro® Fly C GREEN	Sixto® Fly C	Octo® Fly	Octo® Fly C
Maximum capacity	6 adults		8 adults	10 adults	
Capacity recommended	4		6	8	
Length / Width	12,95 x 3,85 m		14,95 x 3,85 m	14,95 x 3,85 m	
ROOM LAYOUT					
Cabins	2 + saloon		3 + saloon	4 + saloon	
Double-beds (140 x 190 cm)	2 + saloon		2 + saloon	4 + saloon	
Double-beds (160 x 190 cm)	-		1	-	
Single-bed (70 x 190 cm)	4 possible		4 possible	8 possible	
Bathroom / electric toilets	2		3	4	
Saloon	11 m ²		11 m ²	11 m ²	
KITCHEN EQUIPMENT					
200 L fridge (freezer)	●		●	●	●
4 ring-hob	●		●	●	●
Oven	●		●	●	●
Dishwasher	●		●	-	●
Microwave	●		●	●	●
« Senseo » electric coffee maker	●		●	●	●
OTHER INTERIOR EQUIPMENT					
Air conditioning	●		●	-	●
Heating	●		●	●	●
Radio, CD, MP3	●		●	●	●
DVD monitor	●		●	●	●
TV with satellite channels	●		●	●	●
Safe	●		●	●	●
Electrical connector 220 V on board	●		●	●	●
OTHER EXTERIOR EQUIPMENT					
Garden furniture	●		●	●	●
Sun awning sliding	●		●	●	●
Sun awning	●		●	●	●
Bathing ladder	●		●	●	●
Shower	●		●	●	●
Gas griddle/BBQ	●		●	●	●
Sunbathing	●		●	●	●
Double steering position	●		●	●	●
Double bow thruster (stern and bow)	●		●	●	●
Water tank capacity	600 L		1050 L	1050 L	1050 L
Fuel tank capacity	375 L	Electric powered	375 L	270 L	270 L

All photos and descriptions are non-contractual. We reserve the right to modify them without prior notice.



Comfort and equipment



QUATTRO® FLY C GREEN

NEW



QUATTRO® FLY C / FLY C GREEN



Full details on page 47

Recommended for 2 couples or 1 couple with 2 children

- 2 cabins + convertible living room
- 2 showers / 2 electric toilets
- On the fly: Alfresco dining area / outdoor kitchen

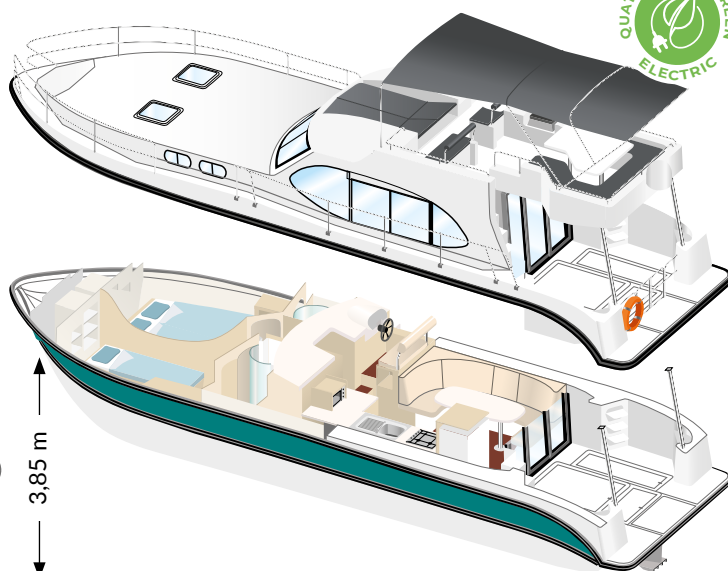
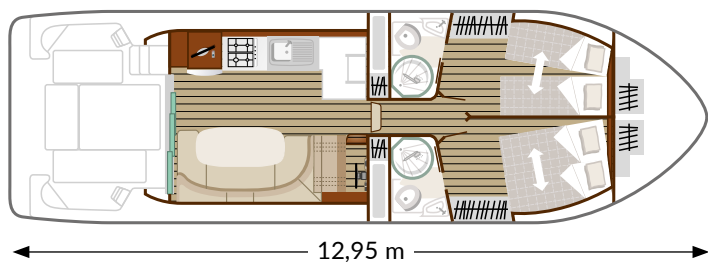

Just like the Sixto® Green, the Quattro Fly C Green is a completely silent, "zero emission" rated, non-polluting and environmentally-friendly electric powered canal boat*!



Comfort and equipment



SIXTO® FLY C



Full details on page 47

Recommended for 3 couples or 2 couples with 2 children

- 3 cabins + convertible living room
- 3 showers / 3 electric toilets
- On the fly: Alfresco dining area / outdoor kitchen

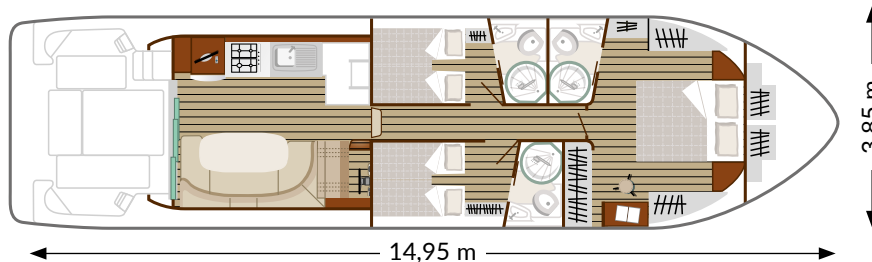

Comfort and equipment



OCTO® FLY



OCTO® FLY C



Full details on page 47

Recommended for 4 couples or 2 couples with 4 children

- 4 cabins + convertible living room
- 4 showers / 4 electric toilets
- On the fly: Alfresco dining area / outdoor kitchen

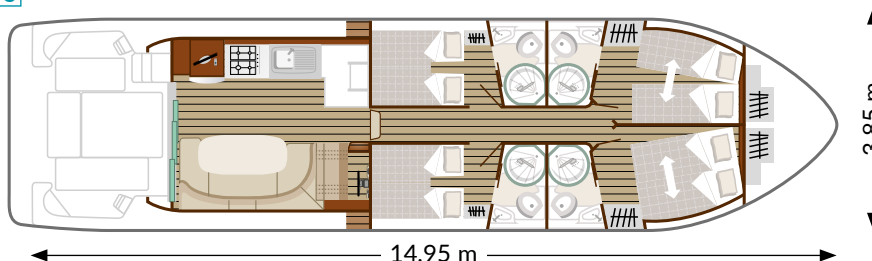

ESTIVALE RANGE

Discover the range of boats on offer



KEY FACTS

- The very best facilities and equipment
- Two steering positions
- Beautiful living space - living room and terrace
- 2-10 people



DOUBLE STEERING POSITION



REAR TERRACE



KITCHEN SIXTO® PRESTIGE / C

	Duo®	Quattro® B Quattro® S	Sixto® Prestige C	Sixto®	Sixto® Green	Octo®
Maximum capacity	4 adults	6 adults	4 adults	8 adults		10 adults
Capacity recommended	2	4	4	6		8
Length / Width	8,85 x 3,40 m	10,85 x 3,80 m	13,50 x 3,80 m	13,50 x 3,80 m		13,50 x 3,80 m
ROOM LAYOUT						
Cabins	1 + saloon	2 + saloon	2 + saloon	3 + saloon		4 + saloon
Double-beds (140 x 190 cm)	1 + 1 saloon	2 + 1 saloon	1 + 1 saloon	3 + 1 saloon		4 + 1 saloon
Double-beds (160 x 190 cm)	-	-	1	-		-
Single-bed (70 x 190 cm)	-	4 possible (2 on Quattro S®)	2 possible	2 possible		8 possible
Bathroom / electric toilets	1	2 (1 on Quattro S®)	-	-		-
Saloon	8 m ²	9 m ²	11 m ²	11 m ²		11 m ²
KITCHEN EQUIPMENT						
220 L fridge (freezer)	●	●	● (195 L)	●		●
4 ring-hob	● (2 ring-hob)	●	●	●		●
Oven	● (Grill)	●	●	●		●
Dishwasher	-	-	●	-		-
Microwave	-	-	●	-		-
« Senseo » electric coffee maker	-	-	●	-		-
OTHER INTERIOR EQUIPMENT						
Air conditioning	-	-	●	-		-
Heating	●	●	●	●		●
Radio, CD, MP3	●	●	●	●		●
DVD monitor	●	●	●	●		●
TV with satellite channels	-	-	● (1 TV saloon + 1 TV cabin)	-		-
Safe	-	-	●	-		-
Electrical connector 220 V on board	●	●	●	●		●
OTHER EXTERIOR EQUIPMENT						
Garden furniture	●	●	●	●		●
Sun awning sliding	●	●	●	●		●
Sun awning	-	-	●	-		-
Bathing ladder	●	●	●	●		●
Shower	●	●	●	●		●
Double steering position	●	-	●	●		●
Stem propeller	-	Quattro® : - Quattro® B : ● Quattro® S : ●	●	●		●
Water tank capacity	750 L	750 L	1050 L	1150 L		1150 L
Fuel tank capacity	270 L	270 L	270 L	Sixto®: 270 L	Electric powered	270 L

All photos and descriptions are non-contractual. We reserve the right to modify them without prior notice.



Comfort and equipment

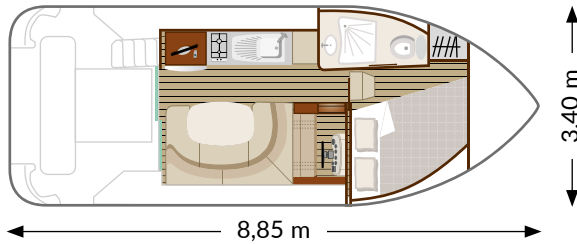

DUO®



Full details on page 49

Recommended for 2 adults

- 1 cabin + convertible living room
- 1 shower / 1 electric toilets



Comfort and equipment

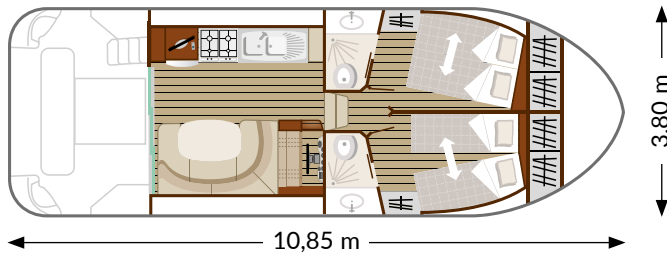

Full details on page 49

Available on Quattro B and Quattro S

QUATTRO® / QUATTRO® B

Recommended for 2 couples or 1 couple and 2 children

- 2 cabins + convertible living room
- 2 showers / 2 electric toilets

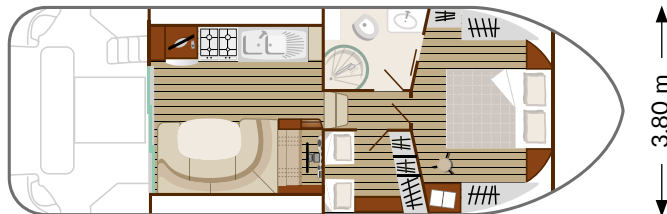

QUATTRO® S

Recommended for 2 couples or 1 couple and 2 children

- 2 cabins + convertible living room
- 1 shower / 1 electric toilets



Comfort and equipment

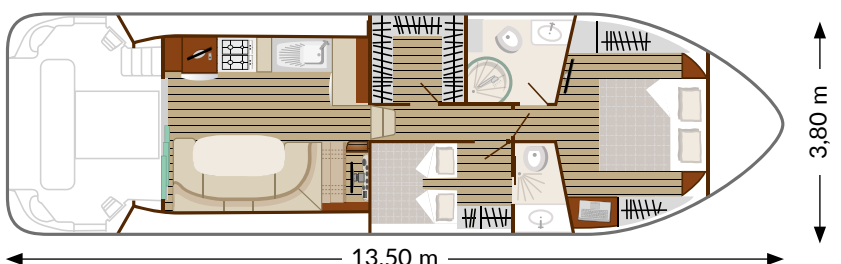

SIXTO® PRESTIGE C



Full details on page 49

Recommended for 2 couples or 1 couple and 2 children

- 2 cabins + convertible living room
- 1 dressing
- 2 showers / 2 electric toilets



Comfort and equipment



SIXTO® GREEN



Nicols® is proud to have been the first boat builder and holiday operator in Europe to launch a 100% electric powered canal boat. With a totally silent engine and zero emissions the Sixto® Green is non-polluting and environmentally friendly*.

Recommended for 3 couples or 2 couples with 2 children

- 3 cabins + convertible living room
- 2 showers / 2 electric toilets



VNF CHARGING TERMINAL**

** VNF charging terminals and their moorings are reserved exclusively for electric boats. *100% of the electricity supplied by EDF on the charging terminals is guaranteed to be renewable (source VNF).

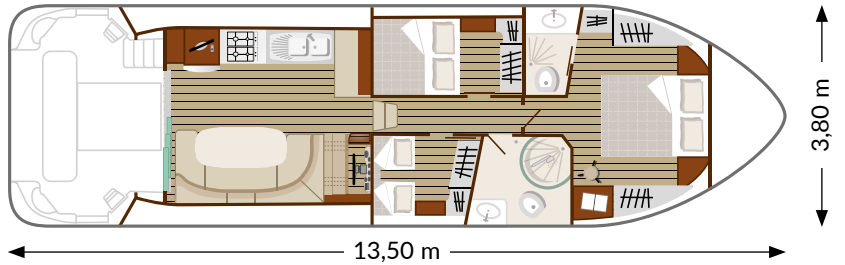

Lithium batteries on board are fast to charge with only two hours charging time needed to provide a cruising range of between six to eight hours, so enough for between a day and a day and a half of navigation. VNF's fast charging terminals are located all along the waterways at approximately every 11km which mean you can stop wherever you want whenever you want.

NB: Available cruise information is available on page 33 (Alsace region).



Comfort and equipment



SIXTO®



Full details on page 49

Recommended for 3 couples or 2 couples with 2 children

- 3 cabins + convertible living room
- 2 showers / 2 electric toilets

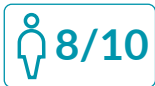
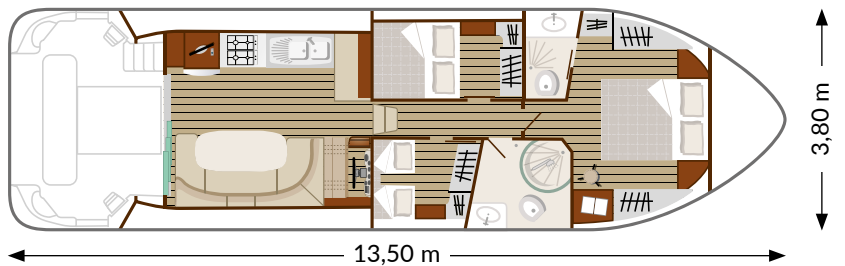

Comfort and equipment



OCTO®



Full details on page 49

Recommended for 4 couples or 2 couples with 4 children

- 4 cabins + convertible living room
- 2 showers / 2 electric toilets

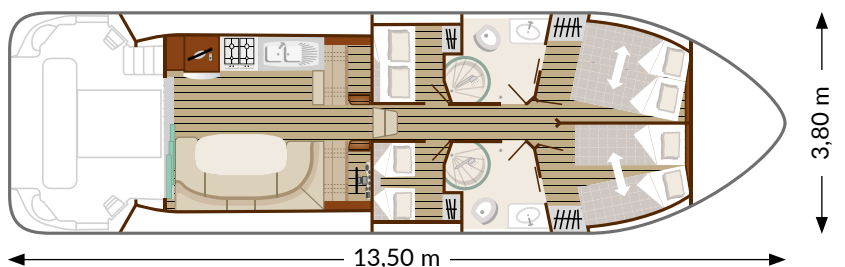

CONFORT RANGE



CONFORT 1350 - 4/6

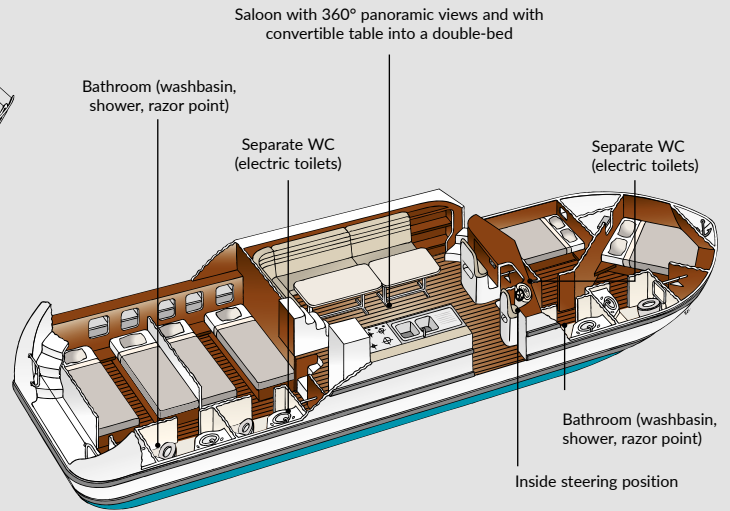
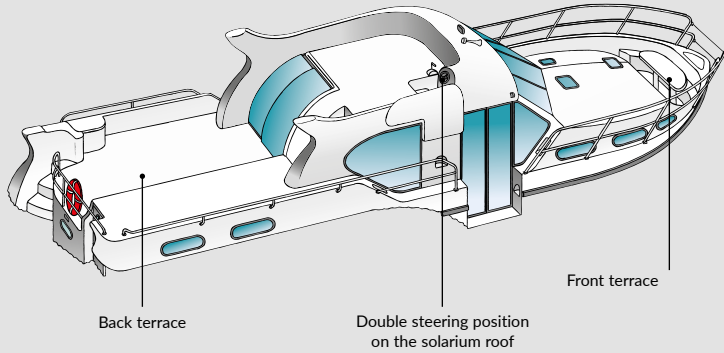

KEY FACTS

- Private bathroom for each cabin
- Ideal for couples
- Front and rear terraces
- 2-10 people



FRONT
TERRACE



SALOON
CONFORT 1100



CABIN
CONFORT 1350 / B

	Confort 900 DP	Confort 1100	Confort 1350 / Confort 1350 B
Maximum capacity	7 people	9 people	10 adults
Capacity recommended	4 adults / 1 child	6 adults / 1 child	8
Length / Width	8,85 x 3,40 m	11,10 x 3,40 m	13,50 x 3,80 m
ROOM LAYOUT			
Cabins	2 + saloon	3 + saloon	4 + saloon
Double-beds (140 x 190 cm)	2 + 1 saloon	3 + 1 saloon	1 saloon + 2 fixed 2 convertible into 4 single-beds
Single-bed (70 x 190 cm)	1	1	4 possibles
Bathroom / electric toilets	2	3	4
Saloon	9 m ²	10 m ²	14 m ²
KITCHEN EQUIPMENT			
220 L fridge (freezer)	●	●	●
2 ring-hob	●	●	-
4 ring-hob	-	-	●
Oven	● (Gril)	●	●
Microwave	-	-	-
« Senseo » electric coffee maker	-	-	-
OTHER INTERIOR EQUIPMENT			
Air conditioning	-	-	-
Heating	●	●	●
Radio, CD, MP3	●	●	●
3 TV (depending on the reception)	-	-	-
Electrical connector 220 V on board	●	●	●
OTHER EXTERIOR EQUIPMENT			
Garden furniture	● (free, on request)	● (free, on request)	●
Sun awning	-	-	-
Bathing ladder	●	●	●
Shower	-	-	-
Double steering position	●	●	●
Stem propeller	-	-	C1350 : - C1350 B : ●
Water tank capacity	800 L	1200 L	1400 L
Fuel tank capacity	300 L	300 L	500 L

All photos and descriptions are non-contractual. We reserve the right to modify them without prior notice.



Comfort and equipment



CONFORT 900 DP



Full details on page 52

Recommended for 2 couples

- 2 cabins + convertible living room
- 2 showers / 2 Electric toilets

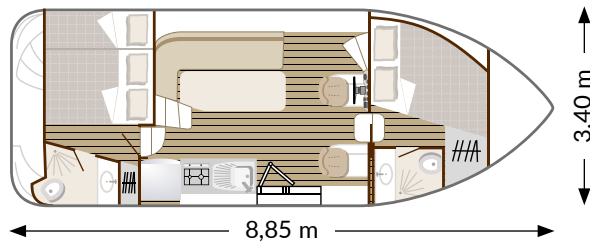

Comfort and equipment



CONFORT 1100



Full details on page 52

Recommended for 3 couples

- 3 cabins + convertible living room
- 3 showers / 3 Electric toilets

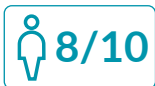
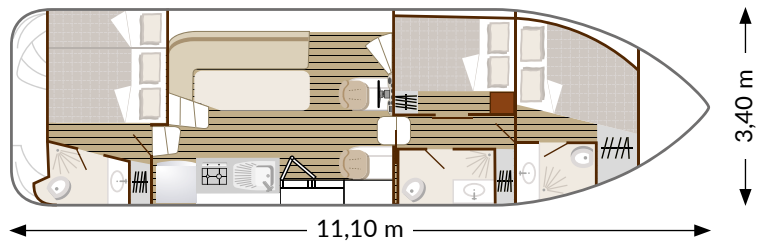

Comfort and equipment



CONFORT 1350



CONFORT 1350 B



Full details on page 52

Recommended for 4 couples

- 4 cabins + convertible living room
- 4 showers / 4 Electric toilets

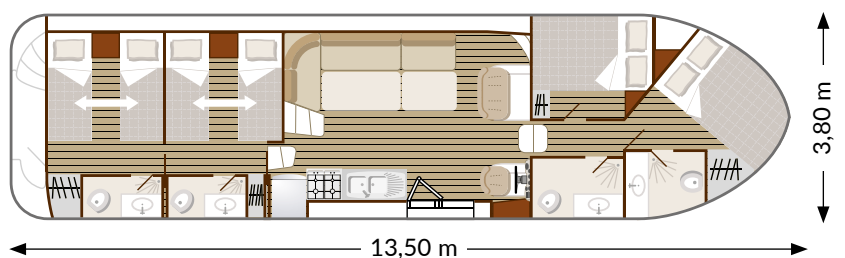

SEDAN RANGE



SEDAN N1170 - 8/10

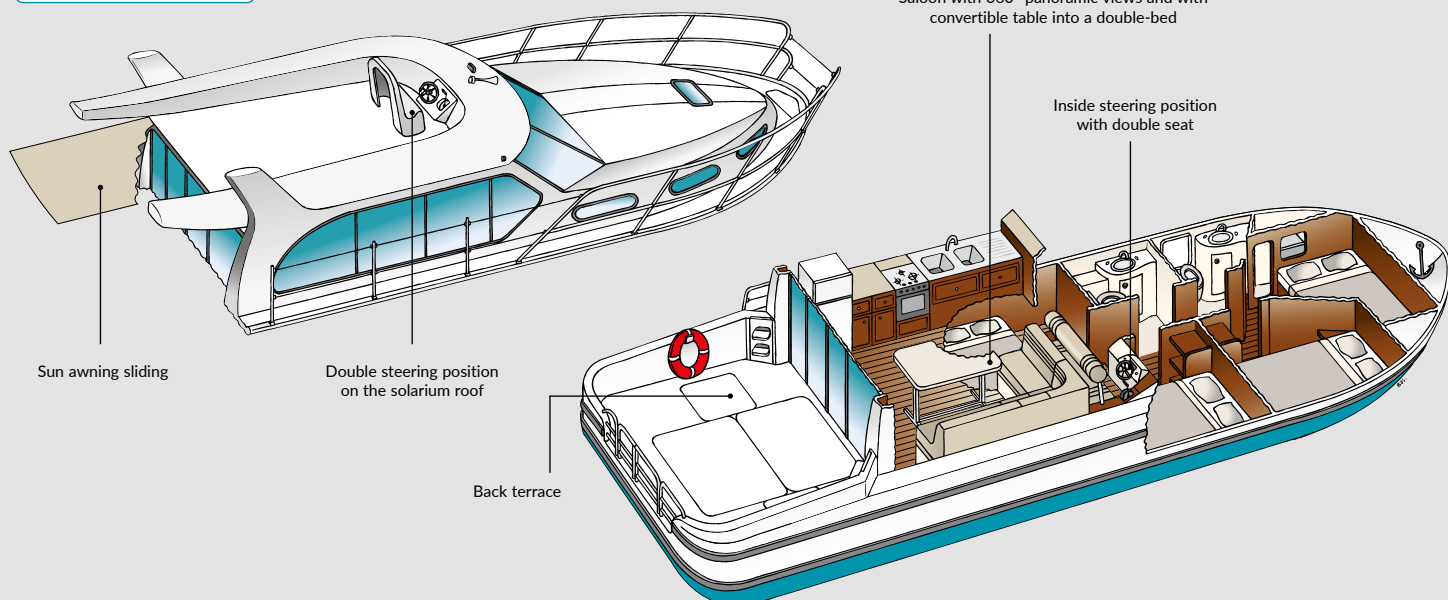

KEY FACTS

- Large living room & panoramic views
- Spacious rear terrace
- Ideal for families
- 2-12 people



REAR TERRACE
SEDAN PRIMO®



SALOON
SEDAN N1000



CABIN
SEDAN PRIMO®

All photos and descriptions are non-contractual. We reserve the right to modify them without prior notice.

	Sedan N800	Sedan Primo®	Sedan N1000	Sedan N1010
Maximum capacity	3 adults	4 adults	8 adults	8 adults
Capacity recommended	2 adults	2 adults	4 adults / 2 children	4 adults / 2 children
Length / Width	8 x 2,50 m	7,95 x 3,40 m	10 x 3,70 m	10 x 3,70 m
ROOM LAYOUT				
Cabins	1 + saloon	1 + saloon	3 + saloon	3 + saloon
Double-beds (140 x 190 cm)	1 + saloon	1 + 1 saloon	3 + 1 saloon	3 + saloon
Single-bed (70 x 190 cm)	-	-	-	-
Bathroom / toilets	1	1	2	2
Saloon	5 m ²	7 m ²	10 m ²	10 m ²
KITCHEN EQUIPMENT				
220 L fridge (freezer)	-	-	●	●
130 L. fridge + freezer	-	●	-	-
56 L. Fridge	●	-	-	-
3 ring-hob	-	-	●	●
2 ring-hob	●	●	-	-
Oven	-	●	●	●
OTHER INTERIOR EQUIPMENT				
Heating	●	●	●	●
Radio, CD, MP3	●	●	●	●
Electrical connector 220 V on board	-	●	-	-
OTHER EXTERIOR EQUIPMENT				
Garden furniture	● (free, on request)	● (free, on request)	●	●
Sun awning sliding	-	-	●	●
Bathing ladder	●	●	●	●
Double steering position	-	-	●	●
Water tank capacity	200 L	200 L	600 L	600 L
Fuel tank capacity	130 L	135 L	300 L	300 L



Comfort and equipment



SEDAN N800



Full details on page 54

Recommended for 1 couple

- 1 cabin + convertible living room
- 1 shower / 1 toilets

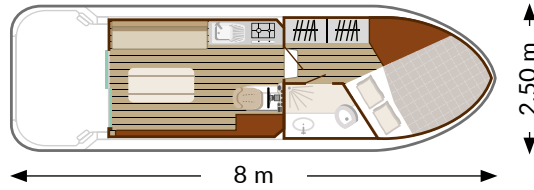

Comfort and equipment



SEDAN PRIMO®



Full details on page 54

Recommended for 1 couple or 1 couple + 2 children

- 1 cabin + convertible living room
- 1 shower / 1 toilets

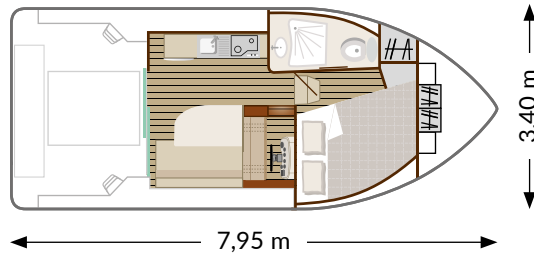

Comfort and equipment



SEDAN N1000

Recommended for 4 adults and 2 children

- 3 cabins + convertible living room
- 2 showers / 2 toilets

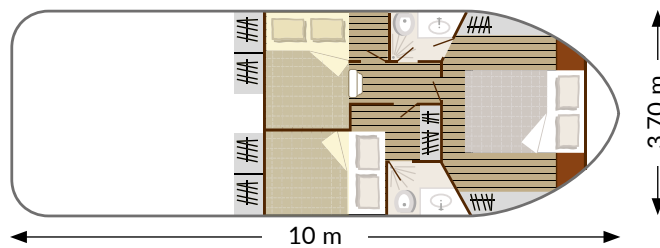

SEDAN N1010

Recommended for 4 adults and 2 children

- 3 cabins + convertible living room
- 2 showers / 2 toilets

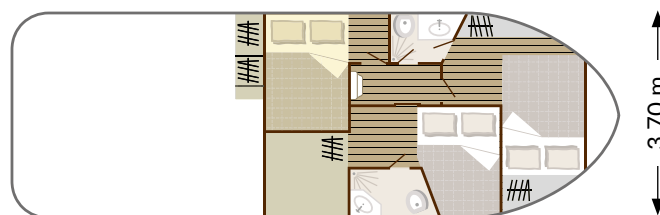

Headroom above bunks: 100 cm maximum

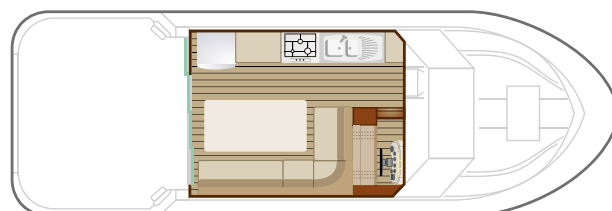

Sedan N1000 & N1010 - Deck plan: saloon table and seating convertible into a double-bed



Comfort and equipment



Full details on page 57

SEDAN N1150



Recommended for 4 adults and 4 children

- 4 cabins + convertible living room
- 2 showers / 2 toilets

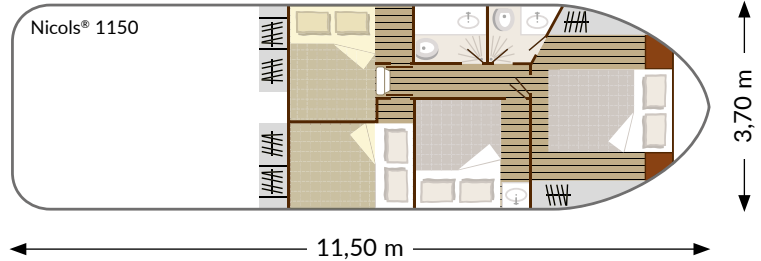

SEDAN N1160



SEDAN N1160N



Recommended for 4 adults and 4 children

- 4 cabins + convertible living room
- 2 showers / 2 toilets (+ 2 washbasins on 1160)

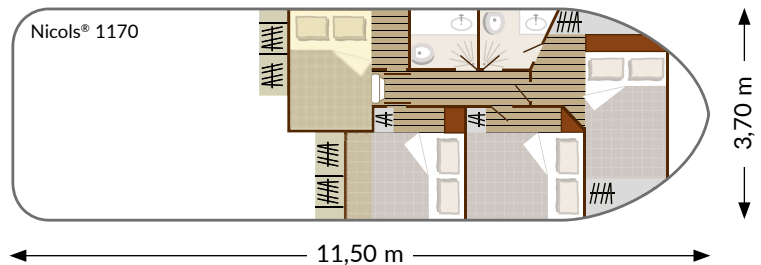
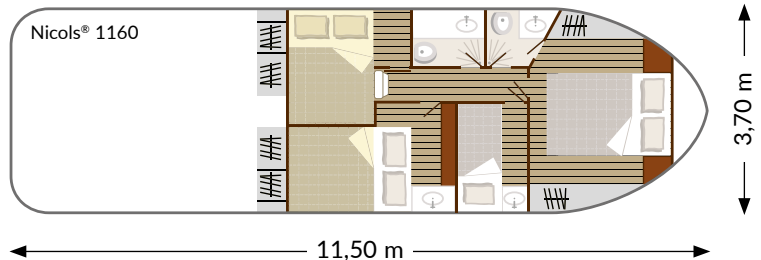

SEDAN N1170



Recommended for 4 adults and 4 children

- 4 cabins + convertible living room
- 2 showers / 2 toilets

Headroom above bunks:
100 cm maximum

Sedan N1150 - N1160 - N1160N & N1170
Deck plan: saloon table and seating convertible into a double-bed

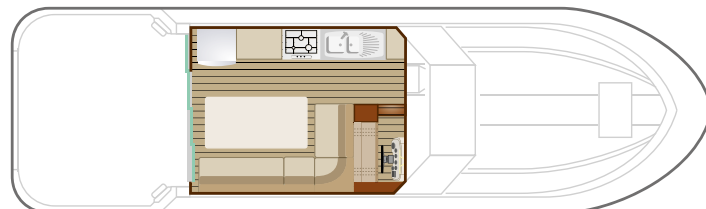



Comfort and equipment



SEDAN N1310



Full details on page 57

Recommended for 6 adults and 4 children

- 5 cabins + convertible living room
- 2 showers / 2 toilets

Headroom above bunks:
100 cm maximum

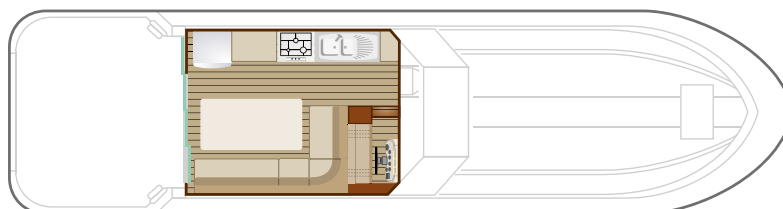
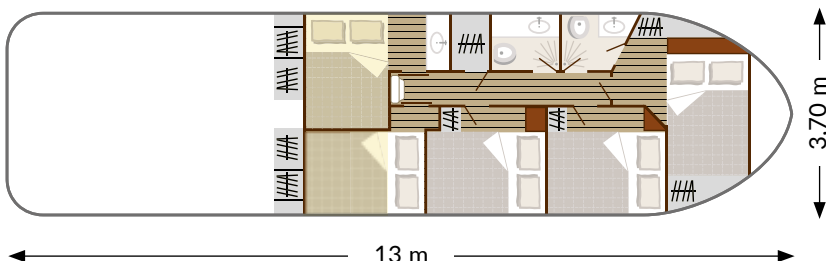

Sedan N1310 - Deck plan:
saloon table and seating convertible
into a double-bed



	Sedan N1150	Sedan N1160 / N1160N	Sedan N1170	Sedan N1310
Maximum capacity	10 adults	10 adults	10 adults	12 adults
Capacity recommended	4 adults / 4 children	4 adults / 4 children	4 adults / 4 children	6 adults / 4 children
Length / Width	11,50 x 3,70 m	11,50 x 3,70 m	11,50 x 3,70 m	13 x 3,70 m
ROOM LAYOUT				
Cabins	4 + saloon	4 + saloon	4 + saloon	5 + saloon
Double-beds (140 x 190 cm)	4 + 1 saloon	3 + 1 saloon	4 + 1 saloon	5 + 1 saloon
Single-bed (70 x 190 cm)	-	2	-	-
Bathroom / toilets	2	2	2	2
Saloon	10 m ²	10 m ²	10 m ²	10 m ²
KITCHEN EQUIPMENT				
220 L fridge (freezer)	•	•	•	•
3 ring-hob	•	•	•	•
Oven	•	•	•	•
OTHER INTERIOR EQUIPMENT				
Heating	•	•	•	•
Radio, CD, MP3	•	•	•	•
Electrical connector 220 V on board	-	(N1160N only)	-	-
OTHER EXTERIOR EQUIPMENT				
Garden furniture	•	•	•	•
Sun awning sliding	•	•	•	•
Bathing ladder	•	•	•	•
Water tank capacity	•	•	•	•
Fuel tank capacity	750 L	750 L	750 L	900 L
Double steering position	300 L	300 L	300 L	300 L

All photos and descriptions are non-contractual. We reserve the right to modify them without prior notice.

RIVIERA RANGE



RIVIERA 920 - 6/8

KEY FACTS

- Charming traditional barges
- Easy handling
- Ideal for a first cruise
- 4-8 people

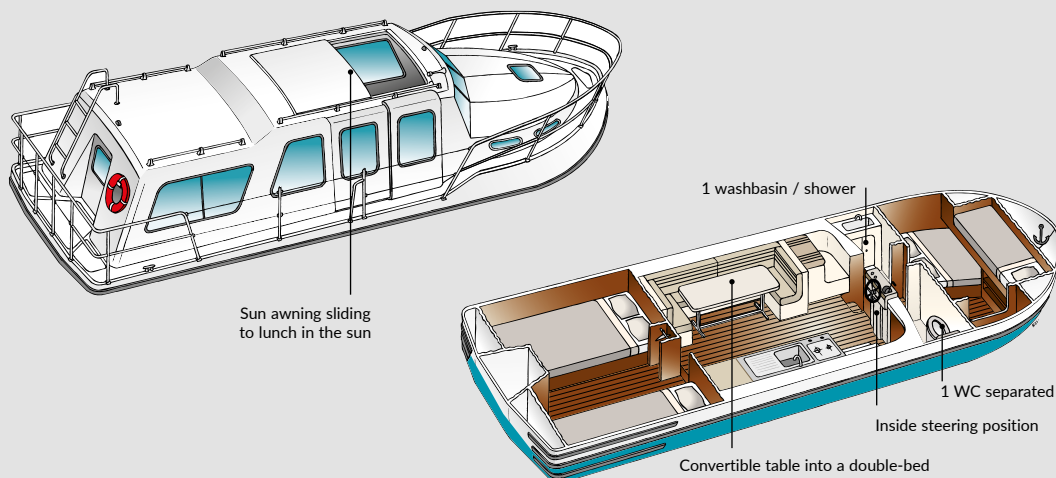

RIVIERA 920



SALOON

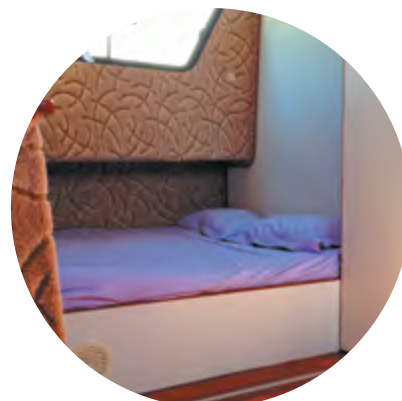

CABINE



Comfort and equipment



RIVIERA 920



Recommended for 5 adults and 1 child

- 2 cabins + convertible living room
- 1 shower / 1 toilets

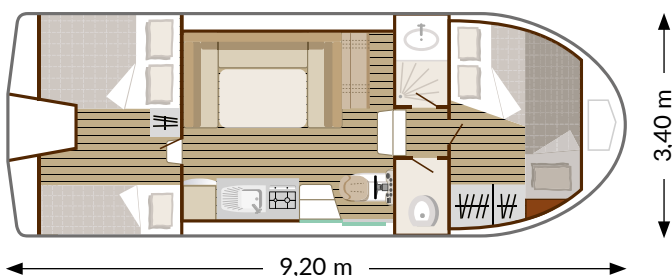

	Riviera 920
Maximum capacity	8 adults
Capacity recommended	5 adults / 1 child
Length / Width	9,20 x 3,40 m
ROOM LAYOUT	
Cabins	2 + saloon
Double-beds (140 x 190 cm)	2 + 1 saloon
Single-bed (70 x 190 cm)	2
Bathroom / toilets	1 / 1
Saloon	8 m ²
KITCHEN EQUIPMENT	
100 L fridge - 2 ring-hob - Oven	•
OTHER INTERIOR EQUIPMENT	
Heating	•
Radio, CD, MP3	•
OTHER EXTERIOR EQUIPMENT	
Bathing ladder	•
Water tank capacity	380 L
Fuel tank capacity	180 L

All photos and descriptions are non-contractual. We reserve the right to modify them without prior notice.

THE NICOLS® STORY



Nicols® began boat construction back in 1986 as part of a wider French industrial group that specialised in the transformation of plastic materials.

In 1990 the first Nicols® base opened in Dole in Franche-Comté. The following year a reservation centre opened to take rental bookings for holidaymakers.

Over 35 years later and Nicols® continue to manage the complete process: boat construction, boat hire and the managing of the bases. Over the years, different generations of boats have been created:

the Marinas, then Riviera, then the easily recognisable 'sea-yacht' shape and renowned terrace of the Sedans, the Confort range that is loved so much by couples and finally the newest Estivale and Fly ranges.

In total there are **five ranges, 28 boat models and nearly 650 craft** that have been produced from the Nicols® boatyard.

BECOME AN OWNER!



Enjoy lazy days on the water all year round



A spacious living area, a fitted kitchen, cabins and bathrooms, a terrace...**your Nicols® boat is as comfortable as a floating home!** Such is the case for some of our clients who have enjoyed it so much, that they have chosen to buy a Nicols® river boat as their **second home**.

Whether new or second hand there is the possibility to have interior fittings altered or made to measure as you wish. The Nicols® boat enthusiasts are not only holidaymakers but also happy boat owners!

For more information on buying a boat - whether new, refurbished, customised or second-hand - please contact Nicols®.

NICOLS®



SECOND HAND
NICOLS® BOATS
FROM JUST:

25.000€

*Price quoted relates to a N800 Sedan.



Cruise on Europe's most beautiful waterways!



Self-drive boating holidays - no experience needed

RCS ANGERS B 338 576 374 - SAS NICOL'S YACHT au Capital de : 152 000 Euros - All photos and descriptions are non-contractual

Follow us:

